

SSR120 Hardware Guide

Published
2025-01-15

Juniper Networks, Inc.
1133 Innovation Way
Sunnyvale, California 94089
USA
408-745-2000
www.juniper.net

Juniper Networks, the Juniper Networks logo, Juniper, and Junos are registered trademarks of Juniper Networks, Inc. in the United States and other countries. All other trademarks, service marks, registered marks, or registered service marks are the property of their respective owners.

Juniper Networks assumes no responsibility for any inaccuracies in this document. Juniper Networks reserves the right to change, modify, transfer, or otherwise revise this publication without notice.

SSR120 Hardware Guide

Copyright © 2025 Juniper Networks, Inc. All rights reserved.

The information in this document is current as of the date on the title page.

YEAR 2000 NOTICE

Juniper Networks hardware and software products are Year 2000 compliant. Junos OS has no known time-related limitations through the year 2038. However, the NTP application is known to have some difficulty in the year 2036.

END USER LICENSE AGREEMENT

The Juniper Networks product that is the subject of this technical documentation consists of (or is intended for use with) Juniper Networks software. Use of such software is subject to the terms and conditions of the End User License Agreement ("EULA") posted at <https://support.juniper.net/support/eula/>. By downloading, installing or using such software, you agree to the terms and conditions of that EULA.

Table of Contents

About This Guide | vi

1

Overview

SSR120 Appliance Overview | 2

Overview | 2

Benefits of SSR120 | 2

SSR120 Models | 3

SSR120 Chassis | 4

Front Panel of an SSR120 | 4

Rear Panel of an SSR120 | 6

Chassis Status LEDs | 6

Network Port LEDs | 7

SSR120 Power System | 9

Cooling System | 10

LTE Support on SSR120 Appliances | 10

Overview | 11

Antennas | 11

Firmware Upgrade Support | 12

2

Site Planning, Preparation, and Specifications

Site Preparation Checklist for SSR120 | 14

SSR120 Site Guidelines and Requirements | 15

General Site Installation Guidelines | 16

Site Electrical Wiring Guidelines | 16

Chassis Physical Specifications for SSR120 | 17

Environmental Requirements and Specifications for SSR120 | 18

Clearance Requirements for Hardware Maintenance of SSR120 | 19

Requirements for Mounting an SSR120 Appliance on a Desktop or Other Level Surface | 20

Rack Requirements for SSR120 | 20

Cable Specifications and Pinouts for SSR120 | 21

Console Port Connector Pinouts for SSR120 | 21

Pluggable Transceivers Supported on SSR120 | 22

3

Initial Installation and Configuration

Unpack and Mount an SSR120 | 24

Unpack an SSR120 | 24

Verify Parts Received with the SSR120 | 25

Update Base Installation Data | 26

Mount an SSR120 on a Desk or Other Level Surface | 26

Mount an SSR120 on a Two-Post Rack | 26

Installing Antennas for the SSR120 Appliances that Support LTE | 28

Inserting the SIM Card | 29

Connect SSR120 to Power | 31

Connect Earth Ground to SSR120 | 31

Connect Power to SSR120 | 32

Power Off the SSR120 | 33

Connect SSR120 to External Devices | 34

Connect SSR120 to a Management Console | 34

SSR Onboarding Options | 36

Onboarding an SSR Conductor-Managed SSR120 Onto Mist Cloud | 38

Pre-Onboarding Verification | 38

Onboarding a Conductor-Managed SSR120 Through the Mist Portal | 43

Assign SSR120 to a Site | 45

4

Contacting Customer Support and Returning the Chassis or Components**Contacting Customer Support and Returning the Chassis or Components | 50**

How to Return a Hardware Component to Juniper Networks, Inc. | 50

Locating the Chassis Serial Number | 51

Contact Customer Support to Obtain a Return Material Authorization | 51

Guidelines for Packing Hardware Components for Shipment | 52

5

Safety and Compliance Information

Definitions of Safety Warning Levels | 54

General Safety Guidelines and Warnings | 55

Restricted Access Warning | 57

Qualified Personnel Warning | 58

Prevention of Electrostatic Discharge Damage | 59

Fire Safety Requirements | 60

Laser and LED Safety Guidelines and Warnings | 62

Chassis and Component Lifting Guidelines | 67

Radiation from Open Port Apertures Warning | 67

Maintenance and Operational Safety Guidelines and Warnings | 69

Action to Take After an Electrical Accident | 74

General Electrical Safety Guidelines and Warnings | 75

AC Power Electrical Safety Guidelines | 75

SSR120 Agency Approvals | 76

FCC Declarations | 78

Lithium Battery Declaration | 78

About This Guide

Use this guide to install hardware and perform initial software configuration, routine maintenance, and troubleshooting for the SSR120 appliance. After completing the installation and basic configuration procedures covered in this guide, refer to the [Session Smart Router](#) software documentation for information about further software configuration.

1

CHAPTER

Overview

[SSR120 Appliance Overview](#) | 2

[SSR120 Chassis](#) | 4

[LTE Support on SSR120 Appliances](#) | 10

SSR120 Appliance Overview

IN THIS SECTION

- Overview | 2
- Benefits of SSR120 | 2
- SSR120 Models | 3

Overview

The Juniper Networks SSR120 is a software-driven network appliance that is part of the SSR branch portfolio. The SSR120 features four 1 GbE ports, two 1 GbE RJ-45/SFP combo ports, 8 GB of memory, and a 120 GB enterprise-grade solid-state drive (SSD) for storage.

The SSR120 runs the FIPS 140-2 Level 1 compliant Session Smart Router (SSR) software, which provides secure and resilient WAN connectivity.

The SSR120 appliance is available in models with or without LTE support.



Benefits of SSR120

The SSR120 provides these benefits:

- **Zero Trust Security (ZTS)**—The SSR120 ensures ZTS by authenticating all routes and encrypting all session traffic. Applications, devices, or users cannot initiate any session that does not comply with the authentication policies and access rules. The SSR120 supports session Layer 2 through Layer 5 stateful firewall functions, including DoS/DDoS protection, NAT, encryption, VPN, and traffic filtering.

- **Adaptive encryption**—The SSR120 automatically detects traffic encrypted using HTTPs or IPsec and does not reencrypt such traffic. This capability results in improved performance and reduced overhead due to double encryption.
- **Multipath routing and failsafe service delivery**—Application and policy-based multipath routing, intelligent path monitoring, and application delivery capabilities with no loss ensure that application traffic is optimized across multiple paths and delivered despite failures.
- **Wireless WAN support**—In addition to Ethernet connections, Wireless WAN support through the LTE module provides more flexibility in deployments.

SSR120 Models

The SSR120 is available in three different models, with or without LTE support.



NOTE: To use the SSR120 appliance, you must purchase the SSR software subscription license sold separately.

Table 1: SSR120 Models

	SSR120	SSR120-AE	SSR120-AA
RAM	8 GB	8 GB	8 GB
Storage	120 GB SSD	120 GB SSD	120 GB SSD
Form factor	Desktop	Desktop	Desktop
Ports	Four 1-Gigabit Ethernet ports Two 1-Gigabit Ethernet RJ-45/SFP combo ports One USB 3.0 port One RJ-45 Console port	Four 1-Gigabit Ethernet ports Two 1-Gigabit Ethernet RJ-45/SFP combo ports One USB 3.0 port One RJ-45 Console port	Four 1-Gigabit Ethernet ports Two 1-Gigabit Ethernet RJ-45/SFP combo ports One USB 3.0 port One RJ-45 Console port
Fans	One	One	One

Table 1: SSR120 Models (Continued)

	SSR120	SSR120-AE	SSR120-AA
LTE support	No	Yes (integrated LTE modem for North America and Europe)	Yes (integrated LTE modem for Asia Pacific, Australia, and New Zealand)

SSR120 Chassis

IN THIS SECTION

- [Front Panel of an SSR120 | 4](#)
- [Rear Panel of an SSR120 | 6](#)
- [Chassis Status LEDs | 6](#)
- [Network Port LEDs | 7](#)
- [SSR120 Power System | 9](#)
- [Cooling System | 10](#)

Front Panel of an SSR120

[Figure 1 on page 5](#) shows the front panel of an SSR120.

Figure 1: Front Panel Components of SSR120

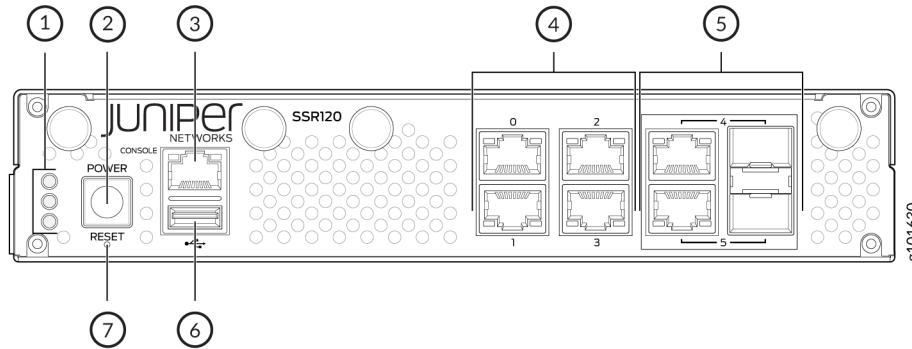

1– Chassis LEDs	5– 1 GbE RJ-45/SFP Combo Ports
2– Power button	6– USB 3.0 port
3– Console Port	7– Reset button
4– 1 GbE Ethernet Ports	

Figure 2 on page 5 shows the front panel components of SSR120-AA and SSR120-AE.

Figure 2: Front Panel Components of SSR120-AA and SSR120-AE

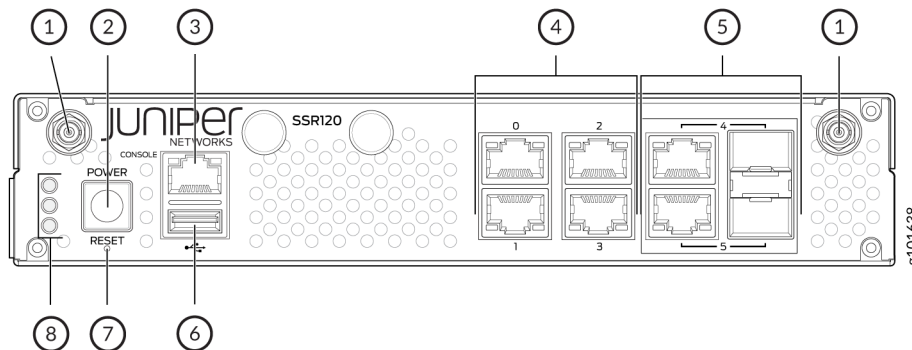

1– Antenna connectors	5– 1 GbE RJ-45/SFP Combo Ports
2– Power button	6– USB 3.0 port
3– Console Port	7– Reset button
4– 1 GbE Ethernet Ports	8– Chassis LEDs

The SSR120 supports two 1 GbE RJ-45/SFP combo ports for WAN connectivity. You can connect either an SFP (fiber) or RJ-45 (copper) cable on the 1 GbE RJ-45/SFP combo port. The SSR120 automatically detects the media that is connected on the combo port.

If you connect both copper and fiber cables, then the media that establishes the link first becomes active and the other media is automatically disabled to save power. If the link goes down, then the disabled media is powered up and both media tries to establish the link again.

Rear Panel of an SSR120

Figure 3 on page 6 shows the rear panel of an SSR120.

Figure 3: SSR120 Rear Panel

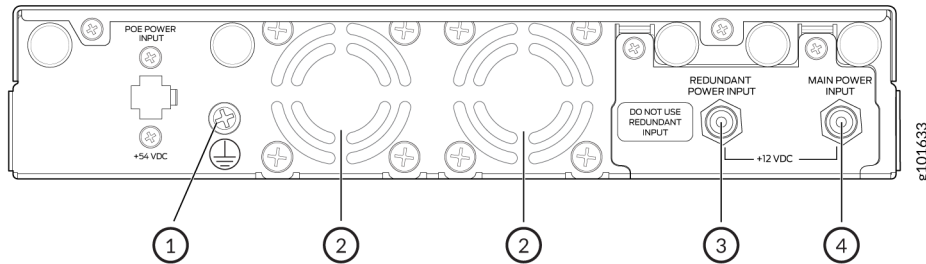

1– Ground terminal

2– Fan

3– Redundant power input (do not use)

4– Main power input



NOTE: The SSR120 does not support the following:

- PoE power input
- Redundant power input

Chassis Status LEDs

The SSR120 has three LEDs on the front panel to indicate the status.

Figure 4: Chassis Status LEDs in an SSR120

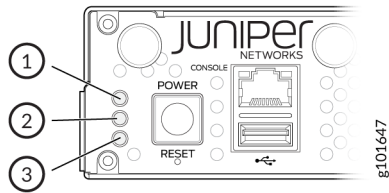

Table 2 on page 7 describes the chassis status LEDs on SSR120, their colors and states, and the status that they indicate.

Table 2: Chassis Status LEDs for SSR120

Status	LED State and Color
OS boot process is complete	LED 1—On, Blue LED 2—Off, Unlit LED 3—On, Blue
Device is powered off by the OS	LED 1—On, Amber LED 2—Off, Unlit LED 3—On, Blue

Network Port LEDs

Each network port has two LEDs to indicate the link activity and status of the port.

Figure 5: Network Port LEDs on SSR120

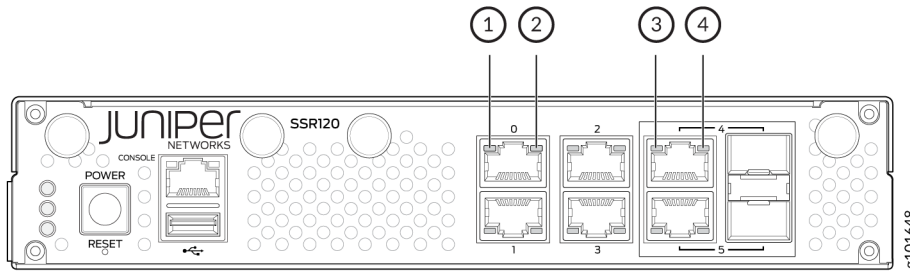

1– Link (Ethernet port)

3– Link (RJ-45/SFP combo port)

2– Activity (Ethernet port)

4– Activity (RJ-45/SFP combo port)

Table 3 on page 8 and Table 4 on page 8 describe the Link and Activity LEDs on the network ports.

Table 3: LED Behavior for Ports 0, 1, 4, and 5 on SSR120

LED	Color	State	Description
Link	Orange	On steadily	1-Gbps link is established.
	Unlit	Off	10-Mbps or 100-Mbps link is established if the Activity LED is also lit green. However, if the Link LED and Activity LED are both unlit, it indicates that there is no link established.
Activity	Green	Blinking	The link is up and there is traffic on the port.
	Green	On steadily	The link is up but there is no traffic on the port.
	Unlit	Off	The link is down.

Table 4: LED Behavior for Ports 2 and 3 on SSR120

LED	Color	State	Description
Link	Orange	On steadily	10-Mbps or 100-Mbps link is established.
	Orange	Blinking	10-Mbps or 100-Mbps link is established and there is traffic on the port

Table 4: LED Behavior for Ports 2 and 3 on SSR120 (Continued)

LED	Color	State	Description
	Unlit	Off	1-Gbps link is established if the Activity LED is also lit green. However, if the Link LED and Activity LED are both unlit, it indicates that there is no link established.
Activity	Green	Blinking	100-Mbps or 1-Gbps link is established and there is traffic on the port.
	Green	On steadily	100-Mbps or 1-Gbps link is established, but there is no traffic on the port.
	Unlit	Off	10-Mbps link is established if the Link LED is also lit orange. However, if the Link LED and Activity LED are both unlit, it indicates that there is no link established.

SSR120 Power System

The SSR120 uses an external AC to DC power adapter.

[Table 5 on page 9](#) lists the specifications for the power supply adapter.

Table 5: Specifications for the SSR120 Power Adapter

Model	Power Adapter Input (AC)	Power Adapter Output (DC)	Maximum Power Consumption
SSR120	100-240V AC, 50-60 Hz, 2 A	12V DC, 5 A	32.5 W
SSR120-AA	100-240V AC, 50-60 Hz, 2 A	12V DC, 5 A	32.5 W
SSR120-AE	100-240V AC, 50-60 Hz, 2 A	12V DC, 5 A	32.5 W

Cooling System

The cooling system of the SSR120 consists of a single fan. The fan controller on the appliance monitors the temperature of the chassis and adjusts the fan speed according to the temperature. The SSR120 appliances have front-to-back airflow. See [Figure 6 on page 10](#).

Figure 6: Front-to-Back Airflow Through the SSR120 Chassis

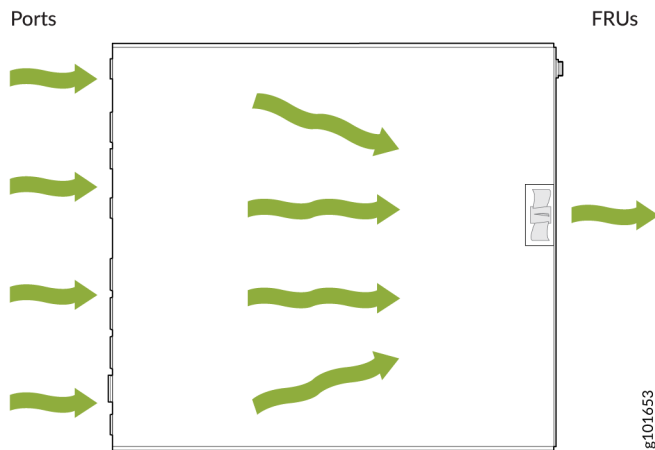

LTE Support on SSR120 Appliances

IN THIS SECTION

- [Overview | 11](#)
- [Antennas | 11](#)
- [Firmware Upgrade Support | 12](#)

Overview

The SSR120 portfolio consists of models with or without LTE support. The LTE support is provided through the in-built LTE module that operates on both 3G and 4G networks. The SSR120 supports only a single SIM card. [Table 6 on page 11](#) provides a summary of the models that support LTE.

Table 6: SSR120 Models That Support LTE

Model	Mode	Operating Region	Frequency Band
SSR120-AE	<ul style="list-style-type: none"> 4G LTE (Cat-6) 3G (HSPA+, UMTS) 	<ul style="list-style-type: none"> North America European Union 	For 4G LTE: <ul style="list-style-type: none"> Bands 1 through 8, 12, 13, 20, 25, 26, 29, 30, and 41 For 3G: <ul style="list-style-type: none"> Bands 1, 2, 3, 4, 5, and 8
SSR120-AA	<ul style="list-style-type: none"> 4G LTE (Cat-6) 3G (HSPA+, UMTS) 	<ul style="list-style-type: none"> Asia Pacific Australia New Zealand 	For 4G LTE: <ul style="list-style-type: none"> Bands 1, 3, 5, 7, 8, 18, 19, 21, 28, 38, 39, 40, and 41 For 3G: <ul style="list-style-type: none"> Bands 1, 5, 6, 8, 9, and 19

Antennas

The LTE module supports two multi-band swivel-mount dipole antennas, which can be rotated 90°. You can rotate the antennas and select the angle at which the signal strength is high. [Table 7 on page 11](#) lists the specifications for the antenna.

Table 7: Antenna Specifications for the LTE Module

Specification	Value
Part Number	AP-DIPOLE-NEXT-C-IW-S2-BL (Airgain)

Table 7: Antenna Specifications for the LTE Module (Continued)

Specification	Value
Operating frequency range	617 MHz-6.0 GHz
Connector type	SMA
Peak Gain	<ul style="list-style-type: none"> • 1.1 dBi @ 617 MHz • 0.7 dBi @ 850 MHz • 2.3 dBi @ 1450 MHz • 1.6 dBi @ 1750 MHz • 2.5 dBi @ 1950 MHz • 2.2 dBi @ 2250 MHz • 2.6 dBi @ 2450 MHz • 2.7 dBi @ 3700 MHz • 3.5 dBi @ 5500 MHz
Impedance	50 Ohms
Dimensions (L x W X H)	252 mm x 35 mm x 13 mm

Firmware Upgrade Support

The LTE module supports over-the-air (OTA) firmware upgrade, which enables automatic and timely upgrade of modem firmware when new firmware versions are available.

2

CHAPTER

Site Planning, Preparation, and Specifications

Site Preparation Checklist for SSR120 | 14

SSR120 Site Guidelines and Requirements | 15

Cable Specifications and Pinouts for SSR120 | 21

Site Preparation Checklist for SSR120

The checklist in [Table 8 on page 14](#) summarizes the tasks you need to perform when preparing a site for SSR120 installation.

Table 8: Site Preparation Checklist

Item or Task	For More Information	Performed by	Date
Environment			
Verify that environmental factors such as temperature and humidity do not exceed appliance tolerances.	"Environmental Requirements and Specifications for SSR120" on page 18		
Power			
Measure the distance between external power sources and the installation site.			
Locate sites for connection of system grounding.			
Calculate the power consumption and requirements.			
Rack			
Verify that your rack or cabinet meets the minimum requirements for the installation of the appliance.	"Rack Requirements for SSR120" on page 20		
Plan rack location, including required space clearances.			
Secure the rack or cabinet to the floor and building structure.			

Table 8: Site Preparation Checklist (Continued)

Item or Task	For More Information	Performed by	Date
Desk			
Verify that the desk meets the minimum requirements for the installation of the appliance.	"Requirements for Mounting an SSR120 Appliance on a Desktop or Other Level Surface" on page 20		
Verify that there is appropriate clearance in your selected location.	"Clearance Requirements for Hardware Maintenance of SSR120" on page 19		
Cables			
<p>Acquire cables and connectors:</p> <ul style="list-style-type: none"> • Determine the number of cables needed based on your planned configuration. • Review the maximum distance allowed for each cable. Choose the length of cable based on the distance between the hardware components being connected. 			
Plan the cable routing and management.			

SSR120 Site Guidelines and Requirements

IN THIS SECTION

- [General Site Installation Guidelines | 16](#)

- Site Electrical Wiring Guidelines | 16
- Chassis Physical Specifications for SSR120 | 17
- Environmental Requirements and Specifications for SSR120 | 18
- Clearance Requirements for Hardware Maintenance of SSR120 | 19
- Requirements for Mounting an SSR120 Appliance on a Desktop or Other Level Surface | 20
- Rack Requirements for SSR120 | 20

General Site Installation Guidelines

The following precautions help you plan an acceptable operating environment for your SSR120 appliance and avoid environmentally caused equipment failures:

- Keep the area around the chassis free from dust.
- Follow prescribed airflow guidelines to ensure that the cooling system functions properly and that exhaust from other equipment does not blow into the intake vents of the appliance.
- Follow the ESD procedures to avoid damaging equipment. Static discharge can cause components to fail completely or intermittently over time.
- Install the appliance in a secure area, so that only authorized personnel can access the appliance.

Site Electrical Wiring Guidelines

Table 9 on page 17 describes the factors you must consider while planning the electrical wiring at your site.



WARNING: You must provide a properly grounded and shielded environment and use electrical surge-suppression devices.

Avertissement Vous devez établir un environnement protégé et convenablement mis à la terre et utiliser des dispositifs de parasurtension.

Table 9: Site Electrical Wiring Guidelines

Site Wiring Factor	Guidelines
Signaling limitations	<p>If your site experiences any of the following problems, consult experts in electrical surge suppression and shielding:</p> <ul style="list-style-type: none"> • Radio frequency interference (RFI) because of improperly installed wires • Damage from lightning strikes occurring when wires exceed recommended distances or pass between buildings • Electromagnetic pulses (EMPs) caused by lightning damaging unshielded conductors and electronic devices
Radio frequency interference	<p>To reduce or eliminate RFI from your site wiring, do the following:</p> <ul style="list-style-type: none"> • Use a twisted-pair cable with a good distribution of grounding conductors. • To exceed the recommended distances, use a high-quality twisted-pair cable with one ground conductor for each data signal, when applicable.
Electromagnetic compatibility	<p>If your site is susceptible to problems with electromagnetic compatibility (EMC), particularly from lightning or radio transmitters, seek expert advice.</p> <p>Strong sources of electromagnetic interference (EMI) can cause:</p> <ul style="list-style-type: none"> • Destruction of the signal drivers and receivers in the device. • Electrical hazards as a result of power surges conducted over the lines into the equipment.

Chassis Physical Specifications for SSR120

Table 10 on page 18 summarizes the physical specifications of SSR120.

Table 10: Physical Specifications of SSR120

Model	Depth	Width	Height	Weight
SSR120	9.49 in. (24.1 cm)	8.74 in. (22.2 cm)	1.73 in. (4.4 cm)	3.68 lb (1.69 kg)
SSR120-AE	9.49 in. (24.1 cm)	8.74 in. (22.2 cm)	1.73 in. (4.4 cm)	3.68 lb (1.69 kg)
SSR120-AA	9.49 in. (24.1 cm)	8.74 in. (22.2 cm)	1.73 in. (4.4 cm)	3.68 lb (1.69 kg)

Environmental Requirements and Specifications for SSR120

The SSR120 must be housed in dry, clean, well-ventilated, and temperature-controlled environment. Follow these environmental guidelines:

- The site must be as dust-free as possible, because dust can clog air intake vent, reducing the efficiency of the cooling system.
- Maintain ambient airflow for normal operation. If the airflow is blocked or restricted, or if the intake air is too warm, the appliance might overheat.

[Table 11 on page 18](#) lists the environmental conditions required for normal operation.

Table 11: Environmental Specifications for SSR120

Description	Value
Operating temperature	0° C to 40° C (32° F to 104° F)
Storage temperature	-20° C to 70° C (-4° F to 158° F)
Altitude	No performance degradation up to 6,562 feet (2,000 meters)

Clearance Requirements for Hardware Maintenance of SSR120

When planning the site for installing an SSR120, you must allow sufficient clearance around the installed chassis.

- For the operating temperature of the SSR120 to be optimal, the airflow around the chassis must be unrestricted.
- For service personnel to remove and install hardware components, and to accommodate the interface and power cable bend radius, there must be adequate space at the front and rear of the appliance. Allow at least 24 in. (61 cm) of space both at the front and the rear of the appliance.
- If you are mounting the appliance in a rack with other equipment, or if you are placing it on the desktop near other equipment, ensure that the exhaust from other equipment does not blow into the intake vents of the chassis.

Figure 7: Clearance Requirements for Hardware Maintenance of SSR120

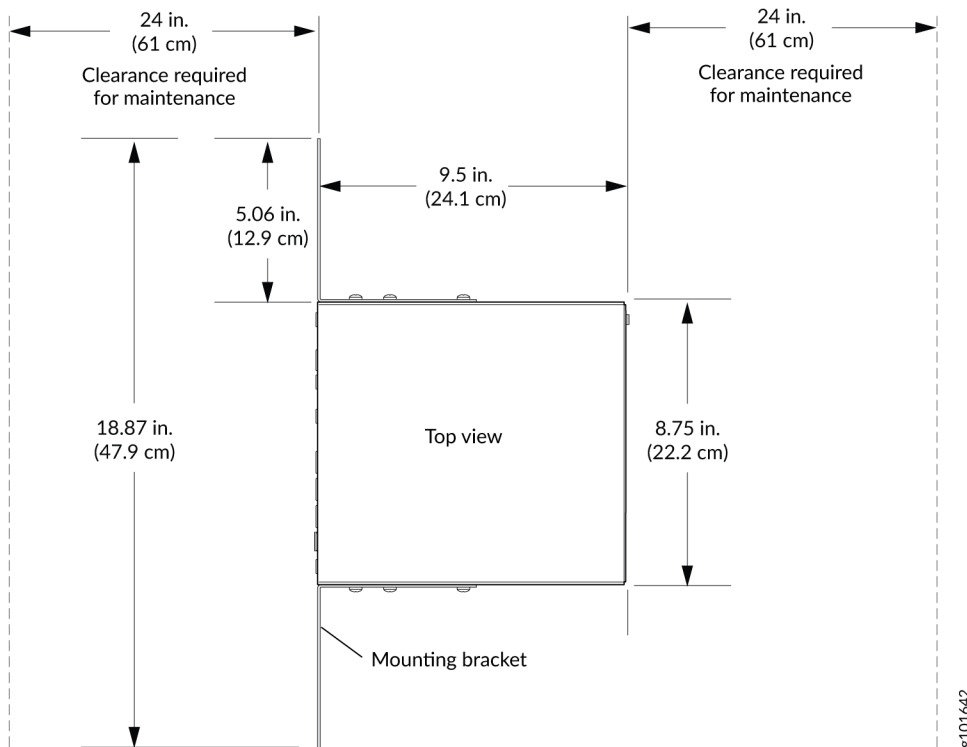

Requirements for Mounting an SSR120 Appliance on a Desktop or Other Level Surface

You can install the SSR120 appliance on a desktop or other such level surface. When choosing a location, allow at least 6 in. (15.2 cm) of clearance between the front and back of the chassis and adjacent equipment or walls. Ensure that the desktop or other level surface on which the appliance is installed is stable and securely supported.

Rack Requirements for SSR120

You can mount the SSR120 on two-post racks. You must order the rack mounting kit (part number: SSR100-RMK) separately. [Table 12 on page 20](#) provides the rack requirements and specifications for SSR120.

Table 12: Rack Requirements and Specifications

Rack Requirement	Guidelines
Rack type	<p>Use a two-post rack that provides bracket holes or hole patterns that are spaced at 1-U increments (1.75 in. or 4.45 cm), and ensure that the rack meets the size and strength requirements to support the weight.</p> <p>A U is the standard rack unit defined in Cabinets, Racks, Panels, and Associated Equipment (document number EIA-310-D) published by the Electronics Industry Association.</p>
Mounting bracket hole spacing	<p>Ensure that the holes in the mounting brackets are spaced at 1 U (1.75 in. or 4.45 cm) so that the appliance can be mounted in any rack that provides holes spaced at that distance.</p>
Rack size and strength	<ul style="list-style-type: none"> • Ensure that the rack complies with the standards for a 19-in. rack as defined in Cabinets, Racks, Panels, and Associated Equipment (document number EIA-310-D) published by the Electronics Industry Association. • Ensure that the spacing of rails and adjacent racks allows for proper clearance around the appliance and rack. • Ensure that the rack rails are spaced widely enough to accommodate the chassis' external dimensions. The outer edges of the front-mounting brackets extend the width to 19 in. (48.26 cm).

Table 12: Rack Requirements and Specifications (Continued)

Rack Requirement	Guidelines
Rack connection to building structure	<ul style="list-style-type: none"> Secure the rack to the building structure. If earthquakes are a possibility in your geographical area, secure the rack to the floor. Secure the rack to the ceiling brackets as well as wall or floor brackets for maximum stability.

Cable Specifications and Pinouts for SSR120

IN THIS SECTION

- [Console Port Connector Pinouts for SSR120 | 21](#)
- [Pluggable Transceivers Supported on SSR120 | 22](#)

Console Port Connector Pinouts for SSR120

The console port is an RS-232 serial interface that uses an RJ-45 connector to connect to a console management device. The default baud rate for the console port is 115200 baud. [Table 13 on page 21](#) provides the pinout information for the RJ-45 console connector. An RJ-45 cable and RJ-45 to DB-9 adapter are supplied with the appliance.

Table 13: Console Port Connector Pinouts

Pin	Signal	Description
1	RTS Output	Request to send
2	DTR Output	Data terminal ready

Table 13: Console Port Connector Pinouts (Continued)

Pin	Signal	Description
3	TxD Output	Transmit data
4	Ground	Ground
5	Ground	Ground
6	RxD Input	Receive data
7	DSR Input	Data set ready
8	CTS Input	Clear to send

Pluggable Transceivers Supported on SSR120

The 1 GbE RJ-45/SFP combo port on the SSR120 supports the following transceivers:

- EX-SFP-1GE-SX
- EX-SFP-1GE-LX

3

CHAPTER

Initial Installation and Configuration

[Unpack and Mount an SSR120 | 24](#)

[Connect SSR120 to Power | 31](#)

[Connect SSR120 to External Devices | 34](#)

[SSR Onboarding Options | 36](#)

[Onboarding an SSR Conductor-Managed SSR120 Onto Mist Cloud | 38](#)

Unpack and Mount an SSR120

IN THIS SECTION

- [Unpack an SSR120 | 24](#)
- [Verify Parts Received with the SSR120 | 25](#)
- [Update Base Installation Data | 26](#)
- [Mount an SSR120 on a Desk or Other Level Surface | 26](#)
- [Mount an SSR120 on a Two-Post Rack | 26](#)
- [Installing Antennas for the SSR120 Appliances that Support LTE | 28](#)
- [Inserting the SIM Card | 29](#)

Unpack an SSR120

The SSR120 is shipped in a cardboard carton and secured with foam packing material. The carton also contains an accessory box and quick start instructions.



NOTE: The SSR120 is maximally protected inside the cardboard carton. Do not unpack it until you are ready to begin installation.

To unpack the SSR120:

1. Move the cardboard carton to a staging area as close to the installation site as possible, where you have enough room to remove the components from the chassis.
2. Position the cardboard carton with the arrows pointing up.
3. Carefully open the top of the cardboard carton.
4. Remove the foam covering the top of the SSR120.
5. Remove the accessory box.
6. Verify the parts received against the lists in [Table 14 on page 25](#).
7. Store the brackets and bolts inside the accessory box.
8. Save the shipping carton and packing materials in case you need to move or ship the services gateway at a later time.

Verify Parts Received with the SSR120

The shipment includes a packing list. Check the parts you receive in the shipping carton against the items on the packing list. The parts shipped depend on the configuration you order.

If any part on the packing list is missing, contact your customer service representative or contact Juniper customer care from within the U.S. or Canada by telephone at 1-888-314-5822. For international-dial or direct-dial options in countries without toll-free numbers, see <https://www.juniper.net/support/requesting-support.html>.

Table 14: Parts List for a Fully Configured SSR120

Component	Quantity
SSR120 Chassis	1
DB-9 to RJ-45 adapter, straight through cable	1
C13 power cord appropriate for your geographical location	1
AC/DC power adapter	1
LTE antennas (provided for SSR120-AA and SSR120-AE models)	2
Rack mount kit (separately orderable) Part Number: SSR100-RMK	<ul style="list-style-type: none"> • 2 mounting brackets • 6 M5x7.0 mm hex-head bracket screws • 4 flat-head M6x16 mm Phillips round head mounting screws • 4 M6 floating nut in cage, steel+zinc • 4 M6 plastic washers
Documentation Roadmap and Product Warranty	1

Update Base Installation Data



CAUTION: Update the installation base data if any addition or change to the installation base occurs or if the installation base is moved. Juniper Networks is not responsible for not meeting the hardware replacement SLA for products that do not have accurate installation base data.

Update your installation base at <https://supportportal.juniper.net/s/CreateCase>.

Mount an SSR120 on a Desk or Other Level Surface

Before mounting SSR120 on a desk or other level surface:

- Verify that the site meets the requirements described in "[SSR120 Site Guidelines and Requirements](#)" on page 15.
- Place the desk in its permanent location, allowing adequate clearance for airflow and maintenance, and secure it to the building structure.
- Read [General Safety Guidelines and Warnings](#), with particular attention to [Chassis and Component Lifting Guidelines](#).



NOTE: Do not block the vents on the enclosure of the SSR120 chassis. Blocking the vents can lead to overheating of the appliance.

To mount a SSR120 on a desk or other level surface:

1. Remove the appliance from the shipping carton (see "[Unpack an SSR120](#)" on page 24).
2. Place the appliance on the desk or the level surface.

Mount an SSR120 on a Two-Post Rack

If you need to mount an SSR120 on a two-post rack you must order the rack-mount kit (SSR100-RMK).

Before mounting an SSR120 on a two-post rack:

- Verify that the site meets the requirements described in "[SSR120 Site Guidelines and Requirements](#)" on page 15.

- Place the rack in its permanent location, allowing adequate clearance for airflow and maintenance, and secure it to the building structure.
- Read [General Safety Guidelines and Warnings](#), with particular attention to [Chassis and Component Lifting Guidelines](#).

Ensure that you have the following parts and tools available:

- Separately orderable rack mount kit (SSR100-RMK)
 - 2 mounting brackets
 - 6 M5x7.0mm flat-head bracket screws
 - 4 flat-head M6x16mm Phillips round head mounting screws
 - 4 M6 floating nut in cage, steel+zinc
 - 4 M6 plastic washers
- Phillips (+) screwdriver, number 2
- 3mm hex tool



NOTE: One person must be available to lift the SSR120 chassis while another secures the chassis to the rack.



CAUTION: If you are mounting multiple units on a rack, mount the heaviest unit at the bottom of the rack and mount the other units from the bottom of the rack to the top in decreasing order of the weight of the units.

To mount the SSR120 on a two-post rack:

1. Remove the SSR120 from the shipping carton (see ["Unpack an SSR120" on page 24](#)).
2. Align the mounting brackets along the front of the appliance such that the holes in the mounting brackets align with the holes on the side panels of the appliance. See [Figure 8 on page 28](#).

Figure 8: Attaching the Mounting Brackets

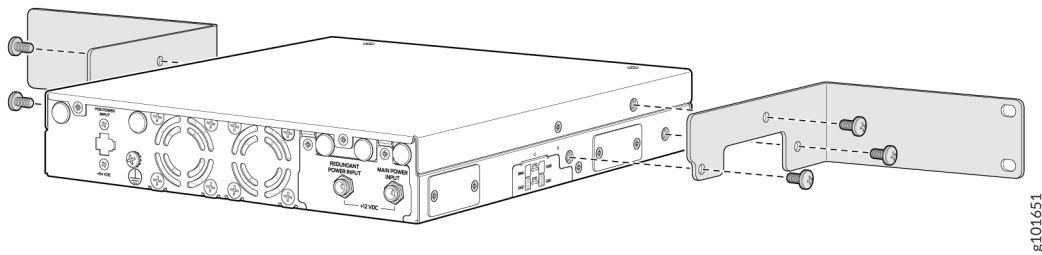

3. Insert the six M5x7.0 mm hex-head bracket screws into the aligned holes and tighten the screws with a torque of 10 Nm. Ensure the curved part of the bracket fits snugly on the lower portion of the appliance's body.
4. Have one person grasp both sides of the appliance, lift the appliance, and position it in the rack, aligning the mounting bracket holes with the threaded holes in the rack rail. Align the bottom hole in each mounting bracket with a hole in each rack rail, making sure the appliance is level. See [Figure 9 on page 28](#).

Figure 9: Mounting the SSR120 on the Rack

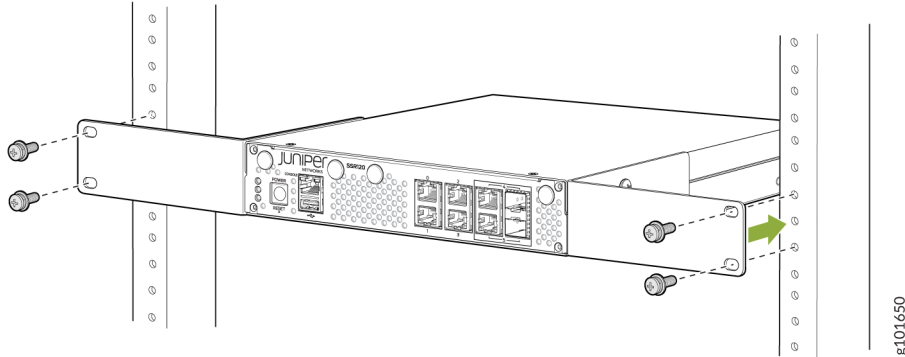

5. Have a second person secure the appliance to the rack by using the 4 flat-head M6x16 mm Phillips round head mounting screws, 4 M6 floating nut in cage, and 4 M6 plastic washers. Tighten the screws with a torque of 18 Nm.
6. Ensure that the appliance is level by verifying that all screws on one side of the rack are aligned with the screws on the other side.

Installing Antennas for the SSR120 Appliances that Support LTE

To install the antennas:

1. Remove the dust caps from the SMA connectors from the SSR120 front panel.
2. Attach the antennas to the SMA connectors and tighten them firmly by hand.

Figure 10: Attaching Antennas to SSR120

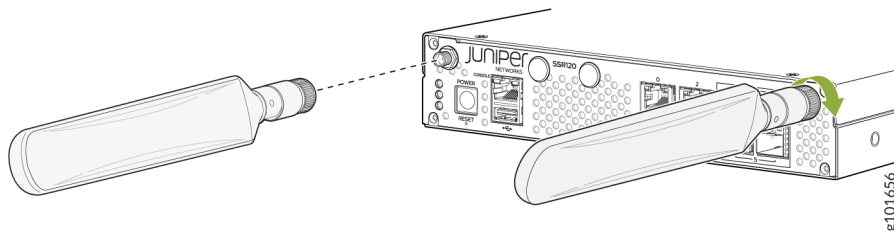

3. Rotate the antennas 0-90 degree in the vertical direction.

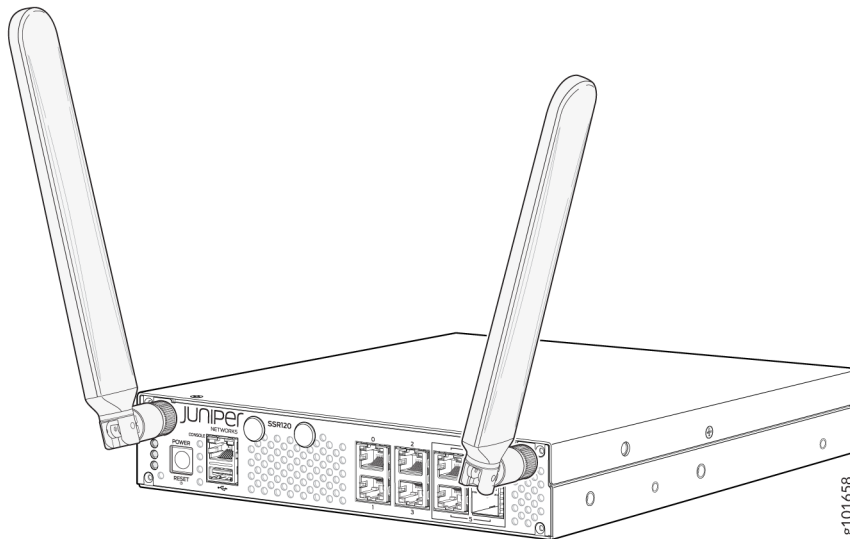

Inserting the SIM Card

The SSR120 LTE Variants (SSR120-AA and SSR120-AE) support Micro-SIM card.

To insert a Micro-SIM card:

1. Using a Philips screwdriver remove the SIM card slot cover on the side of the appliance. See [Figure 11 on page 30](#).

Figure 11: Removing the SIM Card Slot Cover

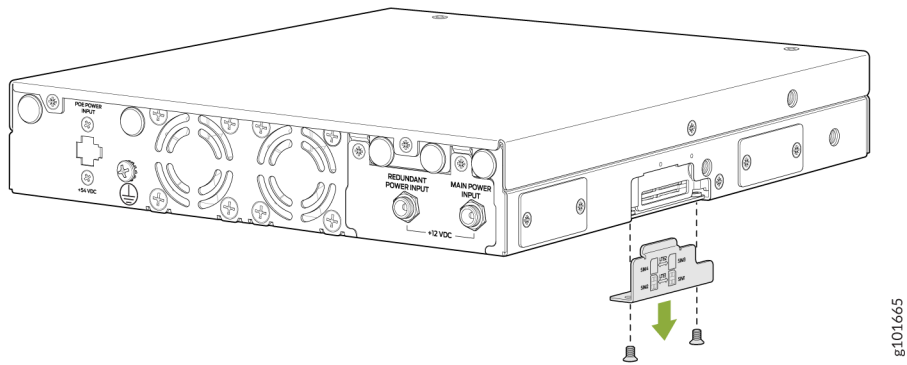

g101665

2. Insert the Micro-SIM card in slot **SIM1**.

Figure 12: Inserting the Micro-SIM Card

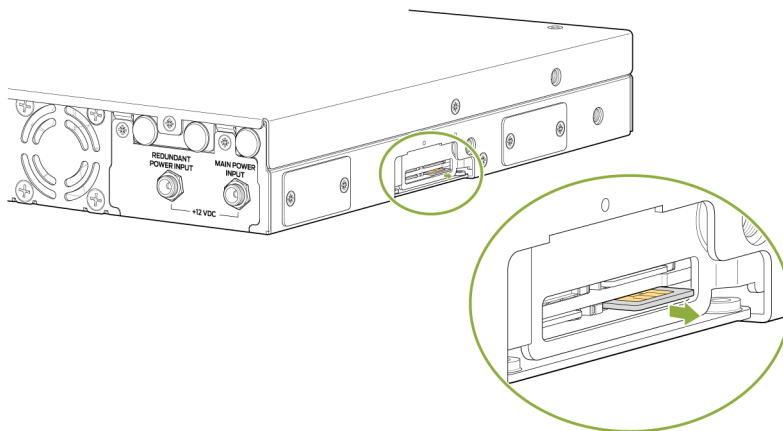

g101666



NOTE: You can insert the Micro-SIM card only in the **SIM1** slot, not in the other SIM slots. When you insert the Micro-SIM card, make sure to orient the card correctly.

3. Replace the SIM card slot cover and tighten its screws with a torque of 6 Nm.

Figure 13: Replacing the SIM Card Slot Cover

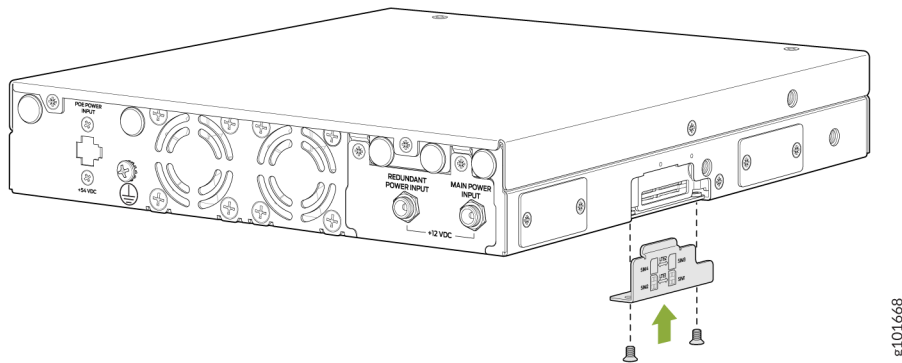

Connect SSR120 to Power

IN THIS SECTION

- [Connect Earth Ground to SSR120 | 31](#)
- [Connect Power to SSR120 | 32](#)
- [Power Off the SSR120 | 33](#)

Connect Earth Ground to SSR120

To meet safety and electromagnetic interference (EMI) requirements and to ensure proper operation, you must connect the chassis to earth ground before you connect it to power.



NOTE: Before you connect an earth ground to the protective earthing terminal of an SSR120 appliance, ensure that a licensed electrician has attached an appropriate ground ring terminal to the grounding cable. Using a grounding cable with an incorrectly attached ring terminal can damage the appliance.

You ground the SSR120 by connecting a grounding cable to earth ground and then attaching the grounding cable to the chassis grounding point located on the rear of the appliance. Under all circumstances, use this grounding connection to ground the chassis. For AC-powered systems, you must

also use the grounding wire in the AC power cord along with the one-hole grounding ring terminal connection. This tested system meets or exceeds all applicable EMC regulatory requirements with the one-hole protective grounding terminal.

To ground the appliance:

1. Wrap and fasten one end of the ESD grounding strap around your wrist and connect the other end to a site ESD point. For more details, see *Prevention of Electrostatic Discharge Damage*.
2. Ensure that all grounding surfaces are clean and brought to a bright finish before grounding connections are made.
3. Connect the grounding cable to a proper earth ground, such as the rack in which the appliance is mounted. The grounding cable must be 14 AWG (1.5 mm²) stranded wire.
4. Using a Phillips screwdriver remove the M4 screw from the grounding point on the rear of the chassis.
5. Place the grounding cable ring terminal attached to the grounding cable over the grounding point.
6. Secure the grounding cable ring terminal to the grounding point with the M4 screw.

Figure 14: Connecting the Grounding Cable to the SSR120

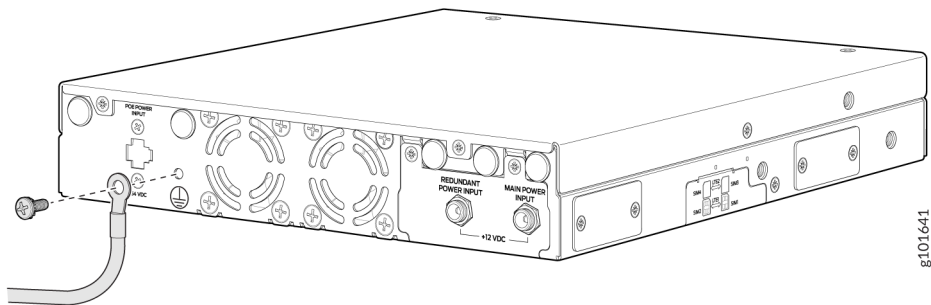

7. Dress the grounding cable and verify that it does not touch or block access to the appliance components and that it does not drape where people could trip on it.



NOTE: The appliance should be permanently connected to ground during operation.

Connect Power to SSR120

Ensure that you have a power cord appropriate for your geographical location.

To connect power to the appliance:

1. Locate the power cord shipped with the appliance.

WARNING: Ensure that the power cord does not drape where people can trip on it or block access to the appliance components.

2. Plug the power cord barrel connector into the **MAIN POWER INPUT** on the appliance and tighten the lock ring. See [Figure 15 on page 33](#).

NOTE: Do not use the **REDUNDANT POWER INPUT**.

Figure 15: Connecting the SSR120 to the Power Supply

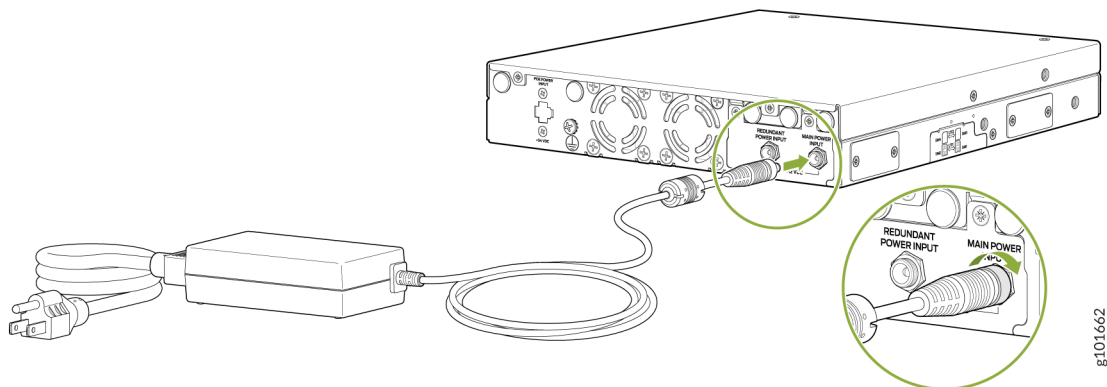

3. If the AC power source outlet has a power switch, set it to the OFF (O) position.
4. Insert the power cord plug into an AC power source outlet.
5. If the AC power source outlet has a power switch, set it to the ON (I) position.

Power Off the SSR120

You can power off the SSR120 in one of the following ways:

- Graceful shutdown—You can do a graceful shutdown in two ways:
 - Use the Linux `poweroff` command at the Console. The appliance begins gracefully shutting down the operating system and then powers itself off.

- Press and hold the **POWER** button for 3 seconds, then release. The appliance begins gracefully shutting down the operating system and then powers itself off.



CAUTION: Use the graceful shutdown method to power off or reboot the appliance.

- Forced shutdown—Press and hold the **POWER** button for 7 seconds, then release. The appliance immediately powers itself off without shutting down the operating system.



CAUTION: Forced shutdown can result in data loss and corruption of the file system. Use the forced shutdown method as a last resort to recover appliance if the appliance operating system is not responding to the graceful shutdown method.



WARNING: Do not press the **POWER** button while the appliance is shutting down.

To remove power completely from the appliance, unplug the power cord or switch off the power source.

After powering off a power supply, wait at least 10 seconds before turning it back on. After powering on a power supply, wait at least 10 seconds before turning it off.

Connect SSR120 to External Devices

IN THIS SECTION

- [Connect SSR120 to a Management Console | 34](#)

Connect SSR120 to a Management Console

Ensure that you have an RJ-45 to DB-9 rollover cable available. An RJ-45 cable with an RJ-45 to DB-9 adapter is provided with the appliance.



NOTE: If your laptop or PC does not have a DB-9 pin contact and you want to connect your laptop or PC directly to the SSR120, use a combination of the RJ-45 cable and RJ-45 to DB-9 adapter supplied with the appliance and a USB to DB-9 plug adapter. You must provide the USB to DB-9 plug adapter.

SSR120 has a console port (**CONSOLE**) with an RJ-45 connector. Use the console port to connect the appliance to a management console or to a console server. The default baud rate of the console port is 115200 bps.

To connect the SSR120 to a management console (see [Figure 16 on page 35](#) and [Figure 17 on page 35](#)):

1. Connect one end of the Ethernet cable to the console port (labeled **CONSOLE**).
2. Connect the other end of the Ethernet cable into the console server (see [Figure 16 on page 35](#)) or management console (see [Figure 17 on page 35](#)).

Figure 16: Connecting the SSR120 to a Management Console Through a Console Server

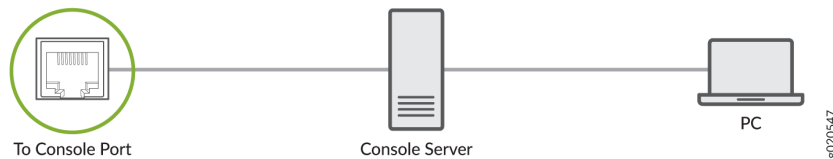
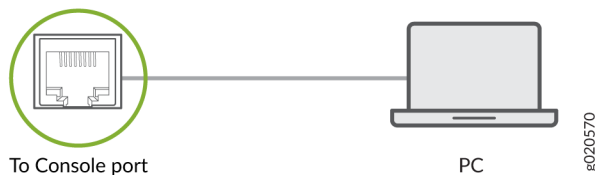

Figure 17: Connecting the SSR120 Directly to a Management Console



SSR Onboarding Options

IN THIS SECTION

- [Onboarding Using Mist | 36](#)
- [Onboarding Into Your Network | 37](#)
- [Onboarding Into an Air Gap Network | 37](#)
- [Software Installation | 37](#)

SSR devices can be Mist-managed or Conductor-managed. If you are onboarding an SSR device that will be Mist-managed, stop here and go to the [SSR QuickStart Guide](#). If you are onboarding a Conductor or Conductor-managed router, read on!

Depending on your deployment, there are the following onboarding options:

- Onboarding Using Mist
- Onboarding into your Network
- Onboarding into an Air-Gap Network

Onboarding Using Mist

For devices shipped with version 5.4.4 of the SSR software, the process described in "[onboarding a conductor-managed router using Mist](#)" on page 38 uses Mist as a vehicle for updating the software and to aid in the configuration process. This requires you to have a conductor already running and configured, ready to accept the router. Refer to [Conductor Installation](#) for more information.

For devices shipped with version 6.3.0 of the SSR software, the process is similar, but requires less user configuration. Refer to the [Initialize Your Device](#) workflow.

Onboarding Into Your Network

In this scenario you directly configure the router to onboard to the conductor. This scenario would take place in a network without access to Mist. Depending upon the version of software shipped with the device, this process requires some manual intervention.

- For devices in a network without access to Mist, and shipped with version 5.4.4 of the software, you must first configure and deploy a Conductor, and then configure the router to onboard to the conductor. See the [SSR Legacy Installation](#) documentation for more information.
- For devices shipped with version 6.3.0 of the SSR software, the process is similar, but requires less user configuration. Refer to the [Initialize Your Device](#) workflow.

Onboarding Into an Air Gap Network

In this scenario you will directly configure the router to onboard to the conductor. This scenario would take place in a situation where the devices are deployed in an "air-gap" network. Depending upon the version of software shipped with the device, this process requires some manual intervention.

- For devices being deployed into an internal network with no internet access (this is referred to as an Air-Gap network) and shipped with version 5.4.4 of the software, please see [Upgrades with Restricted Internet Access](#).
- For devices shipped with version 6.3.0 of the SSR software, the process is similar, but requires less user configuration. Refer to the [Initialize Your Device](#) workflow.

Software Installation

In a case where you would like to install a new version of software directly onto your SSR device (rather than use the upgrade process), refer to the [SSR Software Installation Guide](#). Installation to your device utilizes the SSR ISO, downloaded as a bootable image to a USB drive or from disk.

Onboarding an SSR Conductor-Managed SSR120 Onto Mist Cloud

IN THIS SECTION

- [Pre-Onboarding Verification | 38](#)
- [Onboarding a Conductor-Managed SSR120 Through the Mist Portal | 43](#)
- [Assign SSR120 to a Site | 45](#)

SSR120 comes pre-installed with the Session Smart Router software version 5.4.4. The appliance includes a QR code that when scanned, automatically adopts your device into your Mist Organization. Scan the code using your Mist AI App or a QR Scanner and follow the on-screen instructions to adopt your device.

The Mist App can be downloaded from the following locations:

- For [Apple Device](#)
- For [Android Devices](#)



NOTE: When a SSR120 device is assigned to a site and set to be managed by Mist, you will be prompted to upgrade to a version of software compatible with Mist. In some initial onboarding cases, the upgrade process may take thirty minutes or more. For devices that are to be conductor-managed in a non-Mist environment, see [QuickStart From the OTP ISO](#).

Pre-Onboarding Verification

When onboarding a conductor-managed appliance, the process is simplified by ensuring that the IP address of the managing conductor is configured for the site that will adopt the appliance. This is typically done during Site Configuration.

To verify the conductor IP address has been assigned:

1. Select **Site Configuration** from the **Organization** menu.

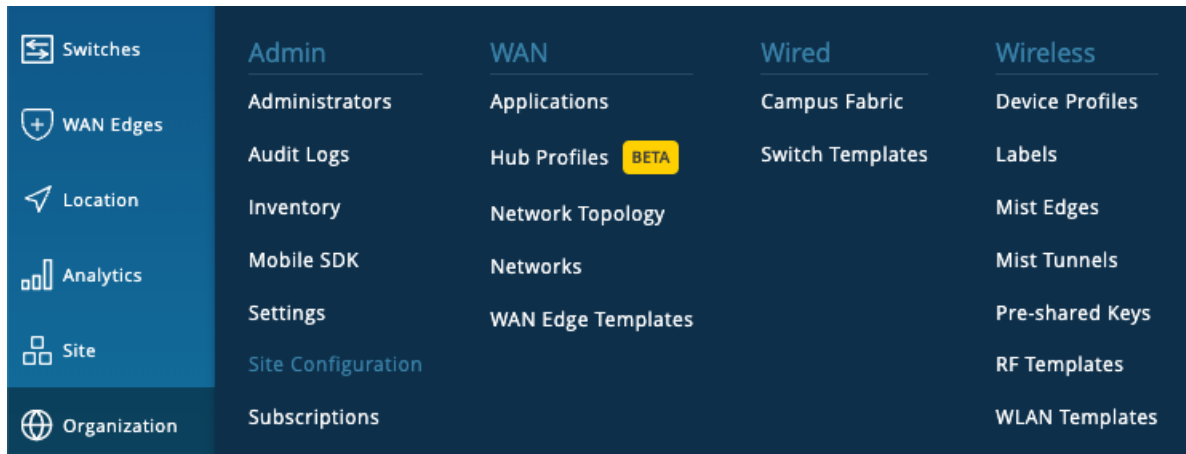

2. Select the Site the appliance will be adopted into from the list of Sites.
3. Scroll down to Session Smart Conductor and verify the IP address.

Mist CHAMPION SSR GLOBAL SES WA 2.0

Monitor
Marvis™
Clients
Access Points
Switches
WAN Edges
Location
Analytics
Site
Organization

Switch Management

Root Password

[Reveal](#)

If no IP address is present, copy the IP address from the SSR GUI.

- a. On the **Configuration Home** panel in the SSR GUI, click **Authority**.

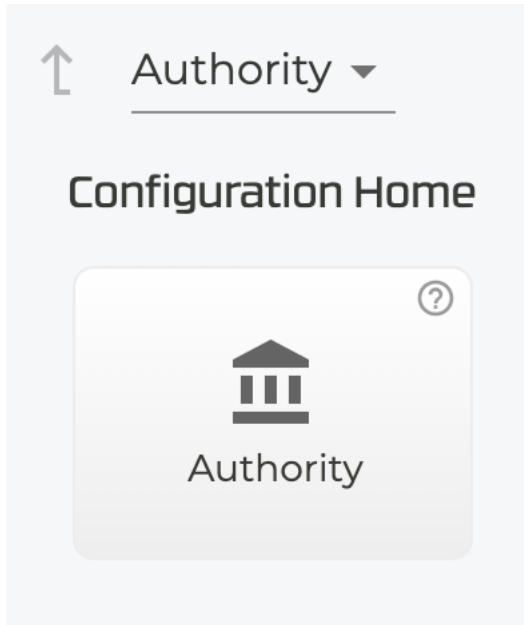

- b. Under **Authority Settings**, scroll down to **Conductor Addresses** and copy the IP address of the conductor.

Juniper Authority128 conductor

Authority Settings

Explore Configuration

DASHBOARD

CUSTOM REPORTS

▼ AUTHORITY

- Conductor
- Routers
- Services
- Tenants
- Topology

▼ CONFIGURATION

- Authority
- Templates
- Import / Export

▼ ADMINISTRATION

- Event History
- Plugins
- Users
- Entitlements

▼ TOOLS

- Ping
- Session Capture
- Routing Details

Basic Information

Name ⓘ
Authority128

Dynamic Hostname Format ⓘ
interface-{interface-id}.{router-name}.{authority-na

Remote Login State ⓘ
false true

Generate Backwards Compatible VRF BGP Tenant Names ⓘ
false true

Authority-wide Routing Filters & Policies

Routing Filters & Policies

Conductor Addresses (1) ⓘ

<input type="checkbox"/>	Conductor Address
<input type="checkbox"/>	10.10.10.6

- Return to the Mist Site Configuration, scroll down to the **Session Smart Conductor** and add the conductor IP address

Mist CHAMPION SSR GLOBAL SES WA 2.0

Switch Management
Root Password

[Reveal](#)

WAN Edge Management
Root Password

[Reveal](#)

Session Smart Conductor
Addresses

(Comma-separated IPs and Max 2)

Site Proxy
Proxy URL

`http://username:password@proxy.internal:8080`

Onboarding a Conductor-Managed SSR120 Through the Mist Portal

Use the following process to onboard a conductor-managed SSR appliance into the Mist cloud using the Mist UI and your claim code.

1. Unbox the SSR120 appliance.

- 2. Connect to the WAN port. The port **0** on the front panel of the SSR120 appliance is the WAN 1 network interface port.

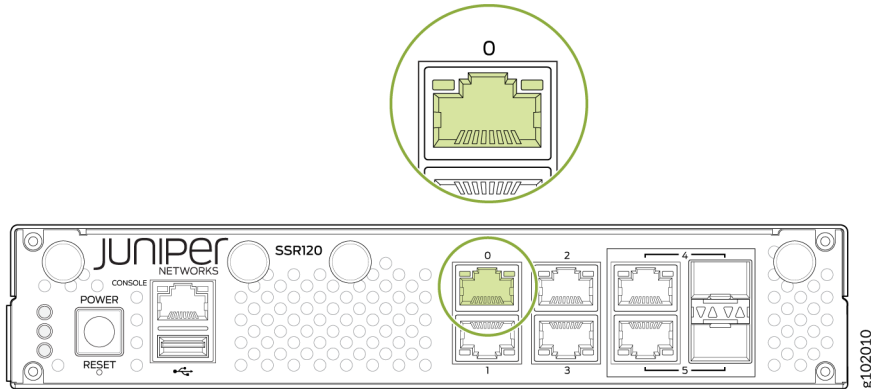

- 3. Power up the SSR120.
- 4. Copy the claim code from the QR sticker. The number listed on the top is the claim code. For example: In the following picture, the claim code is SAMPLECODELABEL.

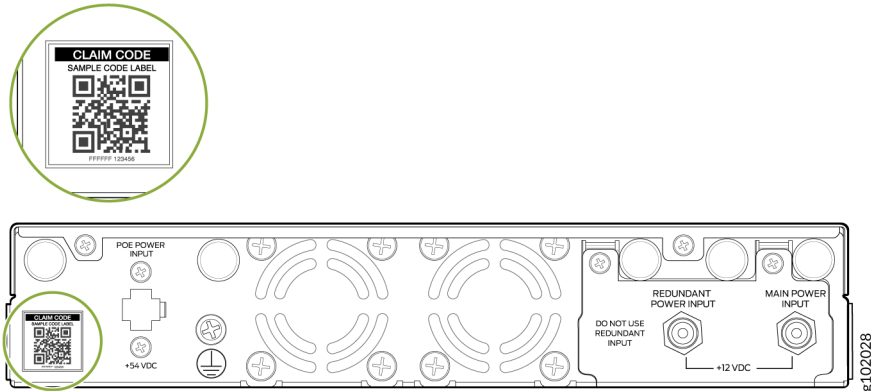

- 5. Login to the Mist UI on another device and navigate to your organization.
- 6. Go to the WAN Edges page and click **Claim WAN Edges**.

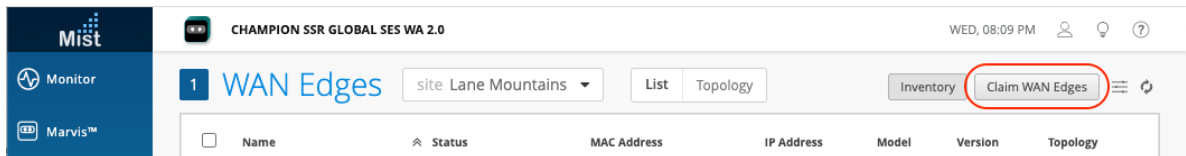

- 7. Enter the claim code.

NOTE: Under **Manage Configuration**, do not check **Manage Configuration with Mist** if your SSR120 is running the SSR software version 5.4.4.

Claim Wan Edges and Activate Subscriptions
✕

Enter WAN Edge claim codes or Activation codes

Site Assignment

Assign claimed WAN Edges to site

Lane Mountains ▾

App Track License

App Track license is used to collect data for monitoring applications and service levels

Use site setting for APP Track license ▾

Name Generation

Generate names for WAN Edges, with format:

Format includes arbitrary text and any/none of these options

- [site] site name
- [site.4] last (1-9) characters of site name
- [mac] MAC address
- [mac.3] last (2-3) bytes of MAC address
- [ctr] incrementing counter
- [ctr.3] counter with (2-6) fixed digits

Manage Configuration

Manage configuration with Mist

Root Password

In the onboarding process, conductor-managed appliances reinitialize to use the factory-default configuration with the conductor IP address. During the initialization process, it reaches out to the conductor and pulls down the appropriate configuration.

After a few minutes, the SSR120 appears in the Inventory with the status as Unassigned. Once it appears in the inventory, it must be assigned to a site. Assign the SSR120 appliance to a site to complete the SSR onboarding.

Assign SSR120 to a Site

After the SSR has been onboarded to the Mist Cloud, assign it to a site to begin managing the appliance configuration and gathering data in Mist.

In the Mist Inventory page, the new appliance shows as **Unassigned**.

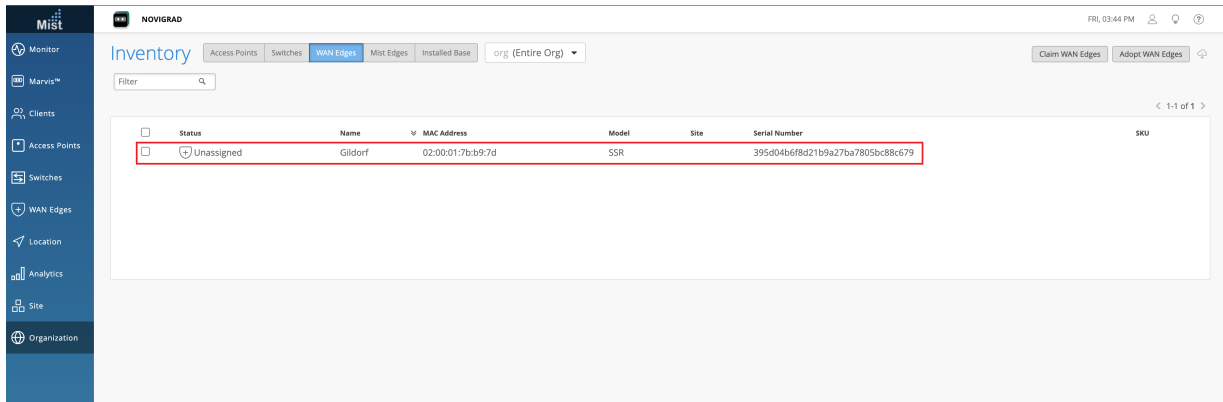

1. Select the new appliance. From the **More** drop-down list, select **Assign to Site**.

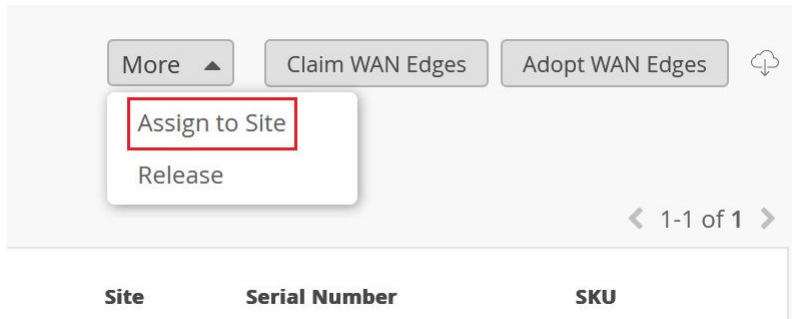

2. Select the site from the **Site** list.

Assign WAN Edges

Assign 1 selected WAN Edge to site site Gildorf

Manage Configuration

Manage configuration with Mist

Unassigned

Search by site name

Gildorf

Assign to Site Cancel

Under **Manage Configuration**, do not check **Manage Configuration with Mist** for the SSR Conductor managed appliance. This allows the device to reach out to the conductor IP address specified when the site was created to receive configuration information.



NOTE: If you are onboarding a Mist-managed appliance using Session Smart Router software version 6.0, select **Manage Configuration with Mist**. If **Manage Configuration with Mist** is not selected, the appliance will not be managed by Mist.

Assign WAN Edges

Assign 1 selected WAN Edge to site site Gildorf

Manage Configuration

Manage configuration with Mist

Existing gateway configuration will be overwritten with Mist configuration. Do not attempt to configure the gateway via CLI once it is managed by Mist. Root password will be configured by the site (under site settings) to which the gateway is assigned.

Assign to Site Cancel

3. Click **Assign to Site**.

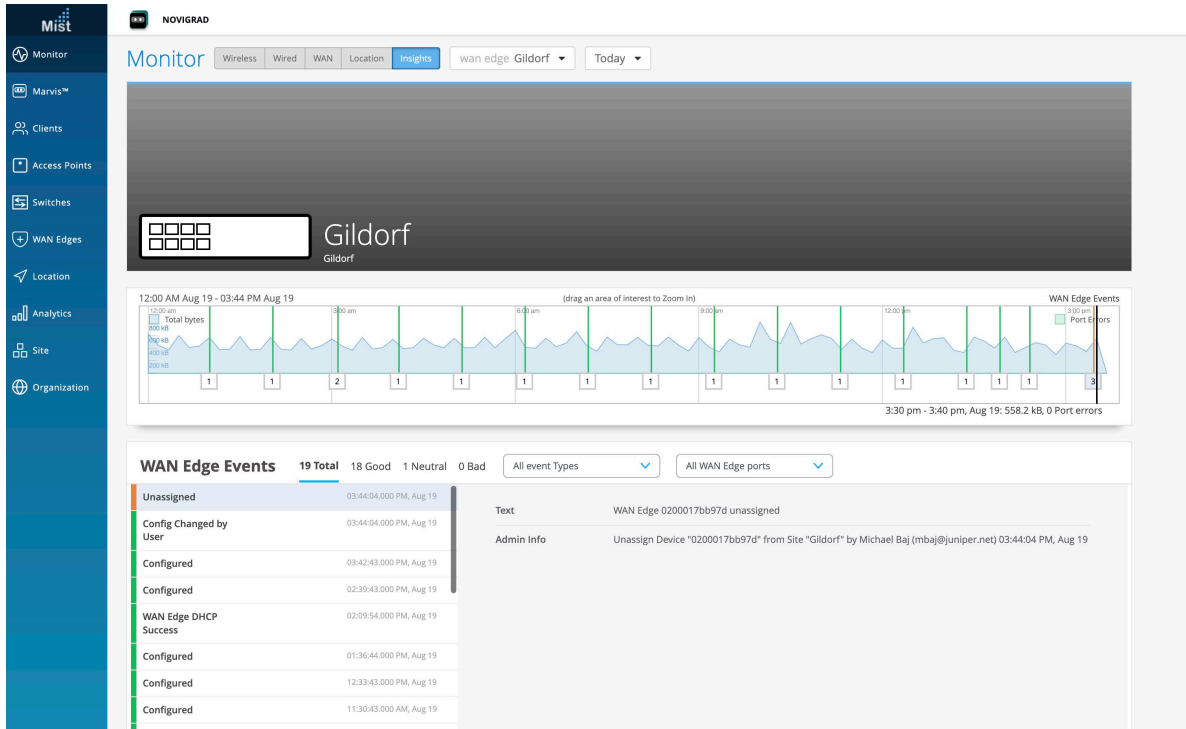

The site assignment will take a few minutes. After the site is fully onboarded, use the **Mist WAN Edge - Device View** to access the appliance, and the **Insights view** to view events and activity.

4

CHAPTER

Contacting Customer Support and Returning the Chassis or Components

Contacting Customer Support and Returning the Chassis or Components | 50

Contacting Customer Support and Returning the Chassis or Components

IN THIS SECTION

- [How to Return a Hardware Component to Juniper Networks, Inc. | 50](#)
- [Locating the Chassis Serial Number | 51](#)
- [Contact Customer Support to Obtain a Return Material Authorization | 51](#)
- [Guidelines for Packing Hardware Components for Shipment | 52](#)

How to Return a Hardware Component to Juniper Networks, Inc.

If a hardware component fails, please contact Juniper Networks, Inc. to obtain a Return Material Authorization (RMA) number. This number is used to track the returned material at the factory and to return repaired or new components to the customer as needed.



NOTE: Do not return any component to Juniper Networks, Inc. unless you have first obtained an RMA number. Juniper Networks, Inc. reserves the right to refuse shipments that do not have an RMA. Refused shipments are returned to the customer by collect freight.

For more information about return and repair policies, see the customer support webpage at <https://support.juniper.net/support/>.

For product problems or technical support issues, contact the Juniper Networks Technical Assistance Center (JTAC) by using the Service Request Manager link at <https://support.juniper.net/support/> or at 1-888-314-JTAC (within the United States) or 1-408-745-9500 (from outside the United States).

To return a defective hardware component:

1. Determine the part number and serial number of the defective component.
2. Obtain an RMA number from the Juniper Networks Technical Assistance Center (JTAC). You can send e-mail or telephone as described above.
3. Provide the following information in your e-mail message or during the telephone call:
 - Part number and serial number of component

- Your name, organization name, telephone number, and fax number
 - Description of the failure
4. The support representative validates your request and issues an RMA number for return of the component.
 5. Pack the component for shipment.

Locating the Chassis Serial Number

The chassis serial number is located on the top of the chassis.

Figure 18: Location of the Serial Number Label

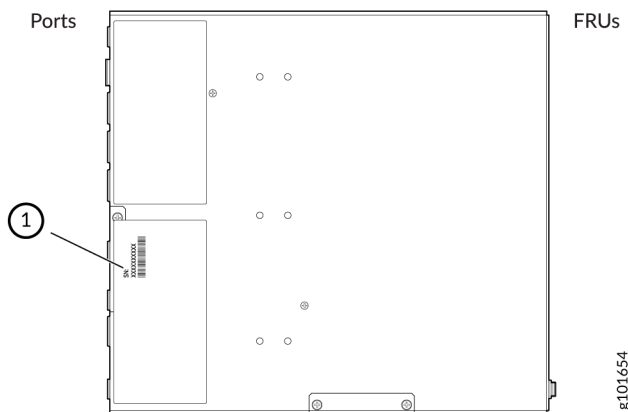

Contact Customer Support to Obtain a Return Material Authorization

If you need to return a device or hardware component to Juniper Networks for repair or replacement, obtain an RMA number from JTAC. You must obtain an RMA number before you attempt to return the component.

After locating the serial number of the device or hardware component you want to return, open a service request with the JTAC on the Web or by telephone.

Before you request an RMA number from JTAC, be prepared to provide the following information:

- Your existing service request number, if you have one
- Serial number of the component
- Your name, organization name, telephone number, fax number, and shipping address
- Details of the failure or problem
- Type of activity being performed on the device when the problem occurred
- Configuration data displayed by one or more `show` commands

You can contact JTAC 24 hours a day, seven days a week, on the Web or by telephone:

- Service Request Manager: <https://support.juniper.net/support>
- Telephone: +1-888-314-JTAC (+1-888-314-5822), toll free in U.S., Canada, and Mexico



NOTE: For international or direct-dial options in countries without toll free numbers, see <https://support.juniper.net/support>.

If you are contacting JTAC by telephone, enter your 12-digit service request number followed by the pound (#) key for an existing case, or press the star (*) key to be routed to the next available support engineer.

The support representative validates your request and issues an RMA number for return of the component.

Guidelines for Packing Hardware Components for Shipment

To pack and ship individual components:

1. When you return components, make sure that they are adequately protected with packing materials and packed so that the pieces are prevented from moving around inside the carton.
2. Use the original shipping materials if they are available.
3. Place each component in an individual electrostatic bag.
4. Write the Return Materials Authorization (RMA) number on the exterior of the box to ensure proper tracking.



CAUTION: Do not stack any of the hardware components.

5

CHAPTER

Safety and Compliance Information

- Definitions of Safety Warning Levels | 54
 - General Safety Guidelines and Warnings | 55
 - Restricted Access Warning | 57
 - Qualified Personnel Warning | 58
 - Prevention of Electrostatic Discharge Damage | 59
 - Fire Safety Requirements | 60
 - Laser and LED Safety Guidelines and Warnings | 62
 - Chassis and Component Lifting Guidelines | 67
 - Radiation from Open Port Apertures Warning | 67
 - Maintenance and Operational Safety Guidelines and Warnings | 69
 - Action to Take After an Electrical Accident | 74
 - General Electrical Safety Guidelines and Warnings | 75
 - AC Power Electrical Safety Guidelines | 75
 - SSR120 Agency Approvals | 76
 - FCC Declarations | 78
 - Lithium Battery Declaration | 78
-

Definitions of Safety Warning Levels

The documentation uses the following levels of safety warnings (there are two *Warning* formats):



NOTE: You might find this information helpful in a particular situation, or you might overlook this important information if it was not highlighted in a Note.



CAUTION: You need to observe the specified guidelines to prevent minor injury or discomfort to you or severe damage to the device.

Attention Veillez à respecter les consignes indiquées pour éviter toute incommodité ou blessure légère, voire des dégâts graves pour l'appareil.



LASER WARNING: This symbol alerts you to the risk of personal injury from a laser.

Avertissement Ce symbole signale un risque de blessure provoquée par rayon laser.



WARNING: This symbol means danger. You are in a situation that could cause bodily injury. Before you work on any equipment, be aware of the hazards involved with electrical circuitry and be familiar with standard practices for preventing accidents.

Waarschuwing Dit waarschuwingssymbool betekent gevaar. U verkeert in een situatie die lichamelijk letsel kan veroorzaken. Voordat u aan enige apparatuur gaat werken, dient u zich bewust te zijn van de bij elektrische schakelingen betrokken risico's en dient u op de hoogte te zijn van standaard maatregelen om ongelukken te voorkomen.

Varoitus Tämä varoitusmerkki merkitsee vaaraa. Olet tilanteessa, joka voi johtaa ruumiinvammaan. Ennen kuin työskentelet minkään laitteiston parissa, ota selvää sähkökytkentöihin liittyvistä vaaroista ja tavanomaisista onnettomuuksien ehkäisykeinoista.

Avertissement Ce symbole d'avertissement indique un danger. Vous vous trouvez dans une situation pouvant causer des blessures ou des dommages corporels. Avant de travailler sur un équipement, soyez conscient des dangers posés par les circuits électriques et familiarisez-vous avec les procédures couramment utilisées pour éviter les accidents.

Warnung Dieses Warnsymbol bedeutet Gefahr. Sie befinden sich in einer Situation, die zu einer Körpervletzung führen könnte. Bevor Sie mit der Arbeit an irgendeinem Gerät

beginnen, seien Sie sich der mit elektrischen Stromkreisen verbundenen Gefahren und der Standardpraktiken zur Vermeidung von Unfällen bewußt.

Avvertenza Questo simbolo di avvertenza indica un pericolo. La situazione potrebbe causare infortuni alle persone. Prima di lavorare su qualsiasi apparecchiatura, occorre conoscere i pericoli relativi ai circuiti elettrici ed essere al corrente delle pratiche standard per la prevenzione di incidenti.

Advarsel Dette varselsymbolet betyr fare. Du befinner deg i en situasjon som kan føre til personskade. Før du utfører arbeid på utstyr, må du være oppmerksom på de faremomentene som elektriske kretser innebærer, samt gjøre deg kjent med vanlig praksis når det gjelder å unngå ulykker.

Aviso Este símbolo de aviso indica perigo. Encontra-se numa situação que lhe poderá causar danos físicos. Antes de começar a trabalhar com qualquer equipamento, familiarize-se com os perigos relacionados com circuitos eléctricos, e com quaisquer práticas comuns que possam prevenir possíveis acidentes.

¡Atención! Este símbolo de aviso significa peligro. Existe riesgo para su integridad física. Antes de manipular cualquier equipo, considerar los riesgos que entraña la corriente eléctrica y familiarizarse con los procedimientos estándar de prevención de accidentes.

Warning! Denna varningssymbol signalerar fara. Du befinner dig i en situation som kan leda till personskada. Innan du utför arbete på någon utrustning måste du vara medveten om farorna med elkretsar och känna till vanligt förfarande för att förebygga skador.

General Safety Guidelines and Warnings

The following guidelines help ensure your safety and protect the device from damage. The list of guidelines might not address all potentially hazardous situations in your working environment, so be alert and exercise good judgment at all times.

- Perform only the procedures explicitly described in the hardware documentation for this device. Make sure that only authorized service personnel perform other system services.
- Keep the area around the device clear and free from dust before, during, and after installation.
- Keep tools away from areas where people could trip over them while walking.
- Do not wear loose clothing or jewelry, such as rings, bracelets, or chains, which could become caught in the device.

- Wear safety glasses if you are working under any conditions that could be hazardous to your eyes.
- Do not perform any actions that create a potential hazard to people or make the equipment unsafe.
- Never attempt to lift an object that is too heavy for one person to handle.
- Never install or manipulate wiring during electrical storms.
- Never install electrical jacks in wet locations unless the jacks are specifically designed for wet environments.
- Operate the device only when it is properly grounded.
- Follow the instructions in this guide to properly ground the device to earth.
- Replace fuses only with fuses of the same type and rating.
- Do not open or remove chassis covers or sheet-metal parts unless instructions are provided in the hardware documentation for this device. Such an action could cause severe electrical shock.
- Do not push or force any objects through any opening in the chassis frame. Such an action could result in electrical shock or fire.
- Avoid spilling liquid onto the chassis or onto any device component. Such an action could cause electrical shock or damage the device.
- Avoid touching uninsulated electrical wires or terminals that have not been disconnected from their power source. Such an action could cause electrical shock.
- Some parts of the chassis, including AC and DC power supply surfaces, power supply unit handles, SFB card handles, and fan tray handles might become hot. The following label provides the warning of the hot surfaces on the chassis:



- Always ensure that all modules, power supplies, and cover panels are fully inserted and that the installation screws are fully tightened.

Restricted Access Warning



WARNING: This unit is intended for installation in restricted access areas. A restricted access area is an area to which access can be gained only by instructed and skilled service personnel through the use of a special tool, lock and key, or other means of security, and which is controlled by the authority responsible for the location.

This unit is not suitable for use in locations where children are likely to be present.

Waarschuwing Dit toestel is bedoeld voor installatie op plaatsen met beperkte toegang. Een plaats met beperkte toegang is een plaats waar toegang slechts door servicepersoneel verkregen kan worden door middel van een speciaal instrument, een slot en sleutel, of een ander veiligheidsmiddel, en welke beheerd wordt door de overheidsinstantie die verantwoordelijk is voor de locatie.

Varoitus Tämä laite on tarkoitettu asennettavaksi paikkaan, johon pääsy on rajoitettua. Paikka, johon pääsy on rajoitettua, tarkoittaa paikkaa, johon vain huoltohenkilöstö pääsee jonkin erikoistyökalun, lukkoon sopivan avaimen tai jonkin muun turvalaitteen avulla ja joka on paikasta vastuussa olevien toimivaltaisten henkilöiden valvoma.

Avertissement Cet appareil est à installer dans des zones d'accès réservé. Ces dernières sont des zones auxquelles seul le personnel de service peut accéder en utilisant un outil spécial, un mécanisme de verrouillage et une clé, ou tout autre moyen de sécurité. L'accès aux zones de sécurité est sous le contrôle de l'autorité responsable de l'emplacement.

Warnung Diese Einheit ist zur Installation in Bereichen mit beschränktem Zutritt vorgesehen. Ein Bereich mit beschränktem Zutritt ist ein Bereich, zu dem nur Wartungspersonal mit einem Spezialwerkzeugs, Schloß und Schlüssel oder anderer Sicherheitsvorkehrungen Zugang hat, und der von dem für die Anlage zuständigen Gremium kontrolliert wird.

Avvertenza Questa unità deve essere installata in un'area ad accesso limitato. Un'area ad accesso limitato è un'area accessibile solo a personale di assistenza tramite un'attrezzo speciale, lucchetto, o altri dispositivi di sicurezza, ed è controllata dall'autorità responsabile della zona.

Advarsel Denne enheten er laget for installasjon i områder med begrenset adgang. Et område med begrenset adgang gir kun adgang til servicepersonale som bruker et spesielt verktøy, lås og nøkkel, eller en annen sikkerhetsanordning, og det kontrolleres av den autoriteten som er ansvarlig for området.

Aviso Esta unidade foi concebida para instalação em áreas de acesso restrito. Uma área de acesso restrito é uma área à qual apenas tem acesso o pessoal de serviço autorizado, que possua uma ferramenta, chave e fechadura especial, ou qualquer outra forma de segurança. Esta área é controlada pela autoridade responsável pelo local.

¡Atención! Esta unidad ha sido diseñada para instalarse en áreas de acceso restringido. Área de acceso restringido significa un área a la que solamente tiene acceso el personal de servicio mediante la utilización de una herramienta especial, cerradura con llave, o algún otro medio de seguridad, y que está bajo el control de la autoridad responsable del local.

Warning! Denna enhet är avsedd för installation i områden med begränsat tillträde. Ett område med begränsat tillträde får endast tillträdas av servicepersonal med ett speciellt verktyg, lås och nyckel, eller annan säkerhetsanordning, och kontrolleras av den auktoritet som ansvarar för området.

Qualified Personnel Warning



WARNING: Only trained and qualified personnel should install or replace the device.

Waarschuwing Installatie en reparaties mogen uitsluitend door getraind en bevoegd personeel uitgevoerd worden.

Varoitus Ainoastaan koulutettu ja pätevä henkilökunta saa asentaa tai vaihtaa tämän laitteen.

Avertissement Tout installation ou remplacement de l'appareil doit être réalisé par du personnel qualifié et compétent.

Warnung Gerät nur von geschultem, qualifiziertem Personal installieren oder auswechseln lassen.

Avvertenza Solo personale addestrato e qualificato deve essere autorizzato ad installare o sostituire questo apparecchio.

Advarsel Kun kvalifisert personell med riktig opplæring bør montere eller bytte ut dette utstyret.

Aviso Este equipamento deverá ser instalado ou substituído apenas por pessoal devidamente treinado e qualificado.

¡Atención! Estos equipos deben ser instalados y reemplazados exclusivamente por personal técnico adecuadamente preparado y capacitado.

Varning! Denna utrustning ska endast installeras och bytas ut av utbildad och kvalificerad personal.

Prevention of Electrostatic Discharge Damage

Device components that are shipped in antistatic bags are sensitive to damage from static electricity. Some components can be impaired by voltages as low as 30 V. You can easily generate potentially damaging static voltages whenever you handle plastic or foam packing material or if you move components across plastic or carpets. Observe the following guidelines to minimize the potential for electrostatic discharge (ESD) damage, which can cause intermittent or complete component failures:

- Always use an ESD wrist strap when you are handling components that are subject to ESD damage, and make sure that it is in direct contact with your skin.

If a grounding strap is not available, hold the component in its antistatic bag (see [Figure 19 on page 60](#)) in one hand and touch the exposed, bare metal of the device with the other hand immediately before inserting the component into the device.



WARNING: For safety, periodically check the resistance value of the ESD grounding strap. The measurement must be in the range 1 through 10 Mohms.

Avertissement Par mesure de sécurité, vérifiez régulièrement la résistance du bracelet antistatique. Cette valeur doit être comprise entre 1 et 10 mégohms (Mohms).

- When handling any component that is subject to ESD damage and that is removed from the device, make sure the equipment end of your ESD wrist strap is attached to the ESD point on the chassis.

If no grounding strap is available, touch the exposed, bare metal of the device to ground yourself before handling the component.

- Avoid contact between the component that is subject to ESD damage and your clothing. ESD voltages emitted from clothing can damage components.
- When removing or installing a component that is subject to ESD damage, always place it component-side up on an antistatic surface, in an antistatic card rack, or in an antistatic bag (see [Figure 19 on page 60](#)). If you are returning a component, place it in an antistatic bag before packing it.

Figure 19: Placing a Component into an Antistatic Bag

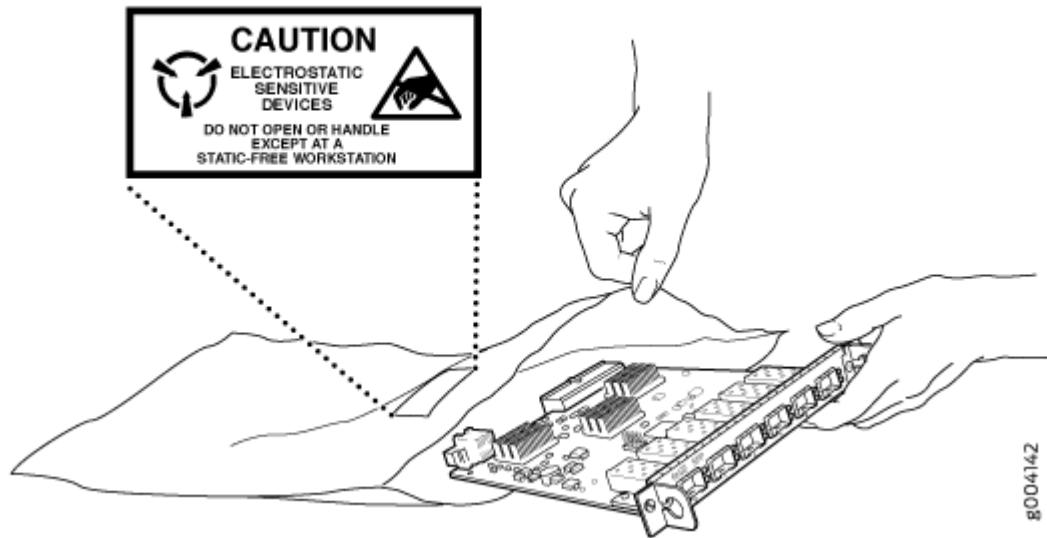

CAUTION: ANSI/TIA/EIA-568 cables such as Category 5e and Category 6 can get electrostatically charged. To dissipate this charge, always ground the cables to a suitable and safe earth ground before connecting them to the system.

Attention Les câbles ANSI/TIA/EIA-568, par exemple Cat 5e et Cat 6, peuvent emmagasiner des charges électrostatiques. Pour évacuer ces charges, reliez toujours les câbles à une prise de terre adaptée avant de les raccorder au système.

Fire Safety Requirements

IN THIS SECTION

- [Fire Suppression | 61](#)
- [Fire Suppression Equipment | 61](#)

In the event of a fire emergency, the safety of people is the primary concern. You should establish procedures for protecting people in the event of a fire emergency, provide safety training, and properly provision fire-control equipment and fire extinguishers.

In addition, you should establish procedures to protect your equipment in the event of a fire emergency. Juniper Networks products should be installed in an environment suitable for electronic equipment. We recommend that fire suppression equipment be available in the event of a fire in the vicinity of the equipment and that all local fire, safety, and electrical codes and ordinances be observed when you install and operate your equipment.

Fire Suppression

In the event of an electrical hazard or an electrical fire, you should first turn power off to the equipment at the source. Then use a Type C fire extinguisher, which uses noncorrosive fire retardants, to extinguish the fire.

Fire Suppression Equipment

Type C fire extinguishers, which use noncorrosive fire retardants such as carbon dioxide and Halotron™, are most effective for suppressing electrical fires. Type C fire extinguishers displace oxygen from the point of combustion to eliminate the fire. For extinguishing fire on or around equipment that draws air from the environment for cooling, you should use this type of inert oxygen displacement extinguisher instead of an extinguisher that leaves residues on equipment.

Do not use multipurpose Type ABC chemical fire extinguishers (dry chemical fire extinguishers). The primary ingredient in these fire extinguishers is monoammonium phosphate, which is very sticky and difficult to clean. In addition, in the presence of minute amounts of moisture, monoammonium phosphate can become highly corrosive and corrodes most metals.

Any equipment in a room in which a chemical fire extinguisher has been discharged is subject to premature failure and unreliable operation. The equipment is considered to be irreparably damaged.



NOTE: To keep warranties effective, do not use a dry chemical fire extinguisher to control a fire at or near a Juniper Networks device. If a dry chemical fire extinguisher is used, the unit is no longer eligible for coverage under a service agreement.

We recommend that you dispose of any irreparably damaged equipment in an environmentally responsible manner.

Laser and LED Safety Guidelines and Warnings

IN THIS SECTION

- [General Laser Safety Guidelines | 62](#)
- [Class 1M Laser Product Warning | 63](#)
- [Class 1M Laser Radiation Warning | 63](#)
- [Class 1 Laser Product Warning | 63](#)
- [Class 1 LED Product Warning | 64](#)
- [Laser Beam Warning | 65](#)
- [Unterminated Fiber-Optic Cable Warning | 65](#)

Juniper Networks devices are equipped with laser transmitters, which are considered a Class 1 or Class 1M Laser Products by the U.S. Food and Drug Administration and are evaluated as a Class 1 Laser Product per EN 60825-1 and EN 60825-2 requirements.

Observe the following guidelines and warnings:

General Laser Safety Guidelines

When working around ports that support optical transceivers, observe the following safety guidelines to prevent eye injury:

- Do not look into unterminated ports or at fibers that connect to unknown sources.
- Do not examine unterminated optical ports with optical instruments.
- Avoid direct exposure to the beam.



LASER WARNING: Unterminated optical connectors can emit invisible laser radiation. The lens in the human eye focuses all the laser power on the retina, so focusing the eye directly on a laser source—even a low-power laser—could permanently damage the eye.

Avertissement Les connecteurs à fibre optique sans terminaison peuvent émettre un rayonnement laser invisible. Le cristallin de l'œil humain faisant converger toute la puissance du laser sur la rétine, toute focalisation directe de l'œil sur une source laser, — même de faible puissance—, peut entraîner des lésions oculaires irréversibles.

Class 1M Laser Product Warning



LASER WARNING: Class 1M laser product.

Waarschuwing Laserproducten van Klasse 1M (IEC).

Varoitus Luokan 1M (IEC) lasertuotteita.

Attention Produits laser catégorie 1M (IEC).

Warnung Laserprodukte der Klasse 1M (IEC).

Avvertenza Prodotti laser di Classe 1M (IEC).

Advarsel Klasse 1M (IEC) laserprodukter.

Aviso Produtos laser Classe 1M (IEC).

¡Atención! Productos láser de Clase 1M (IEC).

Varning! Laserprodukter av Klass 1M (IEC).

Class 1M Laser Radiation Warning



LASER WARNING: Class 1M laser radiation when open. Do not view directly with optical instruments.

Class 1 Laser Product Warning



LASER WARNING: Class 1 laser product.

Waarschuwing Klasse-1 laser produkt.

Varoitus Luokan 1 lasertuote.

Avertissement Produit laser de classe I.

Warnung Laserprodukt der Klasse 1.

Avvertenza Prodotto laser di Classe 1.

Advarsel Laserprodukt av klasse 1.

Aviso Produto laser de classe 1.

¡Atención! Producto láser Clase I.

Varning! Laserprodukt av klass 1.

Class 1 LED Product Warning



LASER WARNING: Class 1 LED product.

Waarschuwing Klasse 1 LED-product.

Varoitus Luokan 1 valodiodituote.

Avertissement Alarme de produit LED Class I.

Warnung Class 1 LED-Produktwarnung.

Avvertenza Avvertenza prodotto LED di Classe 1.

Advarsel LED-produkt i klasse 1.

Aviso Produto de classe 1 com LED.

¡Atención! Aviso sobre producto LED de Clase 1.

Varning! Lysdiodprodukt av klass 1.

Laser Beam Warning



LASER WARNING: Do not stare into the laser beam or view it directly with optical instruments.

Waarschuwing Niet in de straal staren of hem rechtstreeks bekijken met optische instrumenten.

Varoitus Älä katso säteeseen äläkä tarkastele sitä suoraan optisen laitteen avulla.

Avertissement Ne pas fixer le faisceau des yeux, ni l'observer directement à l'aide d'instruments optiques.

Warnung Nicht direkt in den Strahl blicken und ihn nicht direkt mit optischen Geräten prüfen.

Avvertenza Non fissare il raggio con gli occhi né usare strumenti ottici per osservarlo direttamente.

Advarsel Stirr eller se ikke direkte p strlen med optiske instrumenter.

Aviso Não olhe fixamente para o raio, nem olhe para ele directamente com instrumentos ópticos.

¡Atención! No mirar fijamente el haz ni observarlo directamente con instrumentos ópticos.

Warning! Rikta inte blicken in mot strålen och titta inte direkt på den genom optiska instrument.

Unterminated Fiber-Optic Cable Warning



WARNING: Invisible laser radiation might be emitted from the unterminated connector of a fiber-optic cable. To avoid injury to your eye, do not view the fiber optics with a magnifying optical device, such as a loupe, within 100 mm.

Waarschuwing Er kunnen onzichtbare laserstralen worden uitgezonden vanuit het uiteinde van de onafgebroken vezelkabel of connector. Niet in de straal kijken of deze rechtstreeks bekijken met optische instrumenten. Als u de laseruitvoer met bepaalde optische instrumenten bekijkt (zoals bijv. een oogloep, vergrootglas of microscoop) binnen een afstand van 100 mm kan dit gevaar voor uw ogen opleveren.

Varoitus Päätämättömän kuitukaapelin tai -liittimen päästä voi tulla näkymätöntä lasersäteilyä. Älä tuijota sädettä tai katso sitä suoraan optisilla välineillä. Lasersäteen katsominen tietyillä optisilla välineillä (esim. suurennuslasilla tai mikroskoopilla) 10 cm:n päästä tai sitä lähempää voi olla vaarallista silmille.

Attention Des émissions de radiations laser invisibles peuvent se produire à l'extrémité d'un câble en fibre ou d'un raccord sans terminaison. Ne pas fixer du regard le rayon ou l'observer directement avec des instruments optiques. L'observation du laser à l'aide certains instruments optiques (loupes et microscopes) à une distance inférieure à 100 mm peut poser des risques pour les yeux.

Warnung Eine unsichtbare Laserstrahlung kann vom Ende des nicht angeschlossenen Glasfaserkabels oder Steckers ausgestrahlt werden. Nicht in den Laserstrahl schauen oder diesen mit einem optischen Instrument direkt ansehen. Ein Betrachten des Laserstrahls mit bestimmten optischen Instrumenten, wie z.B. Augenlupen, Vergrößerungsgläsern und Mikroskopen innerhalb eines Abstands von 100 mm kann für das Auge gefährlich sein.

Avvertenza L'estremità del connettore o del cavo ottico senza terminazione può emettere radiazioni laser invisibili. Non fissare il raggio od osservarlo in modo diretto con strumenti ottici. L'osservazione del fascio laser con determinati strumenti ottici (come lupette, lenti di ingrandimento o microscopi) entro una distanza di 100 mm può provocare danni agli occhi.

Advarsel Usynlig laserstråling kan emitte fra enden av den ikke-terminerte fiberkabelen eller koblingen. Ikke se inn i strålen og se heller ikke direkte på strålen med optiske instrumenter. Observering av laserutgang med visse optiske instrumenter (for eksempel øyelupe, forstørrelsesglass eller mikroskop) innenfor en avstand på 100 mm kan være farlig for øynene.

Aviso Radiação laser invisível pode ser emitida pela ponta de um conector ou cabo de fibra não terminado. Não olhe fixa ou diretamente para o feixe ou com instrumentos ópticos. Visualizar a emissão do laser com certos instrumentos ópticos (por exemplo, lupas, lentes de aumento ou microscópios) a uma distância de 100 mm pode causar riscos à visão.

¡Atención! El extremo de un cable o conector de fibra sin terminación puede emitir radiación láser invisible. No se acerque al radio de acción ni lo mire directamente con instrumentos ópticos. La exposición del ojo a una salida de láser con determinados instrumentos ópticos (por ejemplo, lupas y microscopios) a una distancia de 100 mm puede comportar lesiones oculares.

Warning! Osynlig laserstrålning kan komma från änden på en oavslutad fiberkabel eller -anslutning. Titta inte rakt in i strålen eller direkt på den med optiska instrument. Att titta på laserstrålen med vissa optiska instrument (t.ex. lupper, förstoringsglas och mikroskop) från ett avstånd på 100 mm kan skada ögonen.

Chassis and Component Lifting Guidelines

- Before moving the device to a site, ensure that the site meets the power, environmental, and clearance requirements.
- Before lifting or moving the device, disconnect all external cables and wires. In case of modular chassis, consider removing the FRUs before lifting or moving the device.
- As when lifting any heavy object, ensure that most of the weight is borne by your legs rather than your back. Keep your knees bent and your back relatively straight. Do not twist your body as you lift. Balance the load evenly and be sure that your footing is firm.
- Use the following lifting guidelines to lift devices and components:
 - Up to 39.7 lb (18 kg): One person.
 - 39.7 lb (18 kg) to 70.5 lb (32 kg): Two or more people.
 - 70.5 lb (32 kg) to 121.2 lb (55 kg): Three or more people.
 - Above 121.2 lb (55 kg): Material handling systems (such as levers, slings, lifts and so on) must be used. When this is not practical, specially trained persons or systems must be used (riggers or movers).

Radiation from Open Port Apertures Warning



LASER WARNING: Because invisible radiation might be emitted from the aperture of the port when no fiber cable is connected, avoid exposure to radiation and do not stare into open apertures.

Waarschuwing Aangezien onzichtbare straling vanuit de opening van de poort kan komen als er geen fiberkabel aangesloten is, dient blootstelling aan straling en het kijken in open openingen vermeden te worden.

Varoitus Koska portin aukosta voi emittoitua näkymätöntä säteilyä, kun kuitukaapelia ei ole kytkettynä, vältä säteilylle altistumista äläkä katso avoimiin aukkoihin.

Avertissement Des radiations invisibles à l'il nu pouvant traverser l'ouverture du port lorsqu'aucun câble en fibre optique n'y est connecté, il est recommandé de ne pas regarder fixement l'intérieur de ces ouvertures.

Warnung Aus der Port-Öffnung können unsichtbare Strahlen emittieren, wenn kein Glasfaserkabel angeschlossen ist. Vermeiden Sie es, sich den Strahlungen auszusetzen, und starren Sie nicht in die Öffnungen!

Avvertenza Quando i cavi in fibra non sono inseriti, radiazioni invisibili possono essere emesse attraverso l'apertura della porta. Evitate di esporvi alle radiazioni e non guardate direttamente nelle aperture.

Advarsel Unngå utsettelse for stråling, og stirr ikke inn i åpninger som er åpne, fordi usynlig stråling kan emitteres fra portens åpning når det ikke er tilkoblet en fiberkabel.

Aviso Dada a possibilidade de emissão de radiação invisível através do orifício da via de acesso, quando esta não tiver nenhum cabo de fibra conectado, deverá evitar a exposição à radiação e não deverá olhar fixamente para orifícios que se encontrarem a descoberto.

¡Atención! Debido a que la apertura del puerto puede emitir radiación invisible cuando no existe un cable de fibra conectado, evite mirar directamente a las aperturas para no exponerse a la radiación.

Varning! Osynlig strålning kan avges från en portöppning utan ansluten fiberkabel och du bör därför undvika att bli utsatt för strålning genom att inte stirra in i oskyddade öppningar.

Maintenance and Operational Safety Guidelines and Warnings

IN THIS SECTION

- Battery Handling Warning | 69
- Jewelry Removal Warning | 70
- Lightning Activity Warning | 71
- Operating Temperature Warning | 72
- Product Disposal Warning | 74

While performing the maintenance activities for devices, observe the following guidelines and warnings:

Battery Handling Warning



WARNING: Replacing a battery incorrectly might result in an explosion. Replace a battery only with the same or equivalent type recommended by the manufacturer. Dispose of used batteries according to the manufacturer's instructions.

Waarschuwing Er is ontploffingsgevaar als de batterij verkeerd vervangen wordt. Vervang de batterij slechts met hetzelfde of een equivalent type dat door de fabrikant aanbevolen is. Gebruikte batterijen dienen overeenkomstig fabrieksvoorschriften weggeworpen te worden.

Varoitus Räjähdyksen vaara, jos akku on vaihdettu väärään akkuun. Käytä vaihtamiseen ainoastaan saman- tai vastaavantyyppistä akkua, joka on valmistajan suosittelema. Hävitä käytetyt akut valmistajan ohjeiden mukaan.

Avertissement Danger d'explosion si la pile n'est pas remplacée correctement. Ne la remplacer que par une pile de type semblable ou équivalent, recommandée par le fabricant. Jeter les piles usagées conformément aux instructions du fabricant.

Warnung Bei Einsetzen einer falschen Batterie besteht Explosionsgefahr. Ersetzen Sie die Batterie nur durch den gleichen oder vom Hersteller empfohlenen Batterietyp. Entsorgen Sie die benutzten Batterien nach den Anweisungen des Herstellers.

Advarsel Det kan være fare for eksplosjon hvis batteriet skiftes på feil måte. Skift kun med samme eller tilsvarende type som er anbefalt av produsenten. Kasser brukte batterier i henhold til produsentens instruksjoner.

Avvertenza Pericolo di esplosione se la batteria non è installata correttamente. Sostituire solo con una di tipo uguale o equivalente, consigliata dal produttore. Eliminare le batterie usate secondo le istruzioni del produttore.

Aviso Existe perigo de explosão se a bateria for substituída incorrectamente. Substitua a bateria por uma bateria igual ou de um tipo equivalente recomendado pelo fabricante. Destrua as baterias usadas conforme as instruções do fabricante.

¡Atención! Existe peligro de explosión si la batería se reemplaza de manera incorrecta. Reemplazar la batería EXclusivamente con el mismo tipo o el equivalente recomendado por el fabricante. Desechar las baterías gastadas según las instrucciones del fabricante.

Warning! Explosionsfara vid felaktigt batteribyte. Ersätt endast batteriet med samma batterityp som rekommenderas av tillverkaren eller motsvarande. Följ tillverkarens anvisningar vid kassering av använda batterier.

Jewelry Removal Warning



WARNING: Before working on equipment that is connected to power lines, remove jewelry, including rings, necklaces, and watches. Metal objects heat up when connected to power and ground and can cause serious burns or can be welded to the terminals.

Waarschuwing Alvorens aan apparatuur te werken die met elektrische leidingen is verbonden, sieraden (inclusief ringen, kettingen en horloges) verwijderen. Metalen voorwerpen worden warm wanneer ze met stroom en aarde zijn verbonden, en kunnen ernstige brandwonden veroorzaken of het metalen voorwerp aan de aansluitklemmen lassen.

Varoitus Ennen kuin työskentelet voimavirtajohtoihin kytkettyjen laitteiden parissa, ota pois kaikki korut (sormukset, kaulakorut ja kellot mukaan lukien). Metalliesineet kuumenevat, kun ne ovat yhteydessä sähkövirran ja maan kanssa, ja ne voivat aiheuttaa vakavia palovammoja tai hitsata metalliesineet kiinni liitännänpoihin.

Avertissement Avant d'accéder à cet équipement connecté aux lignes électriques, ôter tout bijou (anneaux, colliers et montres compris). Lorsqu'ils sont branchés à l'alimentation et reliés à la terre, les objets métalliques chauffent, ce qui peut provoquer des blessures graves ou souder l'objet métallique aux bornes.

Warnung Vor der Arbeit an Geräten, die an das Netz angeschlossen sind, jeglichen Schmuck (einschließlich Ringe, Ketten und Uhren) abnehmen. Metallgegenstände erhitzen sich, wenn sie an das Netz und die Erde angeschlossen werden, und können schwere Verbrennungen verursachen oder an die Anschlußklemmen angeschweißt werden.

Avvertenza Prima di intervenire su apparecchiature collegate alle linee di alimentazione, togliersi qualsiasi monile (inclusi anelli, collane, braccialetti ed orologi). Gli oggetti metallici si riscaldano quando sono collegati tra punti di alimentazione e massa: possono causare ustioni gravi oppure il metallo può saldarsi ai terminali.

Advarsel Fjern alle smykker (inkludert ringer, halskjeder og klokker) før du skal arbeide på utstyr som er koblet til kraftledninger. Metallgjenstander som er koblet til kraftledninger og jord blir svært varme og kan forårsake alvorlige brannskader eller smelte fast til polene.

Aviso Antes de trabalhar em equipamento que esteja ligado a linhas de corrente, retire todas as jóias que estiver a usar (incluindo anéis, fios e relógios). Os objectos metálicos aquecerão em contacto com a corrente e em contacto com a ligação à terra, podendo causar queimaduras graves ou ficarem soldados aos terminais.

¡Atención! Antes de operar sobre equipos conectados a líneas de alimentación, quitarse las joyas (incluidos anillos, collares y relojes). Los objetos de metal se calientan cuando se conectan a la alimentación y a tierra, lo que puede ocasionar quemaduras graves o que los objetos metálicos queden soldados a los bornes.

Warning! Tag av alla smycken (inklusive ringar, halsband och armbandsur) innan du arbetar på utrustning som är kopplad till kraftledningar. Metallobjekt hettas upp när de kopplas ihop med ström och jord och kan förorsaka allvarliga brännskador; metallobjekt kan också sammansvetsas med kontakterna.

Lightning Activity Warning



WARNING: Do not work on the system or connect or disconnect cables during periods of lightning activity.

Waarschuwing Tijdens onweer dat gepaard gaat met bliksem, dient u niet aan het systeem te werken of kabels aan te sluiten of te ontkoppelen.

Varoitus Älä työskentele järjestelmän parissa äläkä yhdistä tai irrota kaapeleita ukkosilmalla.

Avertissement Ne pas travailler sur le système ni brancher ou débrancher les câbles pendant un orage.

Warnung Arbeiten Sie nicht am System und schließen Sie keine Kabel an bzw. trennen Sie keine ab, wenn es gewittert.

Avvertenza Non lavorare sul sistema o collegare oppure scollegare i cavi durante un temporale con fulmini.

Advarsel Utfør aldri arbeid på systemet, eller koble kabler til eller fra systemet når det tordner eller lynr.

Aviso Não trabalhe no sistema ou ligue e desligue cabos durante períodos de mau tempo (trovoada).

¡Atención! No operar el sistema ni conectar o desconectar cables durante el transcurso de descargas eléctricas en la atmósfera.

Warning! Vid åska skall du aldrig utföra arbete på systemet eller ansluta eller koppla loss kablar.

Operating Temperature Warning



WARNING: To prevent the device from overheating, do not operate it in an area that exceeds the maximum recommended ambient temperature. To prevent airflow restriction, allow at least 6 in. (15.2 cm) of clearance around the ventilation openings.

Waarschuwing Om te voorkomen dat welke switch van de Juniper Networks router dan ook oververhit raakt, dient u deze niet te bedienen op een plaats waar de maximale aanbevolen omgevingstemperatuur van 40° C wordt overschreden. Om te voorkomen dat de luchtstroom wordt beperkt, dient er minstens 15,2 cm speling rond de ventilatie-openingen te zijn.

Varoitus Ettei Juniper Networks switch-sarjan reititin ylikuumentuisi, sitä ei saa käyttää tilassa, jonka lämpötila ylittää korkeimman suositellun ympäristölämpötilan 40° C. Ettei ilmanvaihto estyisi, tuuletusaukkojen ympärille on jätettävä ainakin 15,2 cm tilaa.

Avertissement Pour éviter toute surchauffe des routeurs de la gamme Juniper Networks switch, ne l'utilisez pas dans une zone où la température ambiante est supérieure à 40° C. Pour permettre un flot d'air constant, dégagez un espace d'au moins 15,2 cm autour des ouvertures de ventilations.

Warnung Um einen Router der switch vor Überhitzung zu schützen, darf dieser nicht in einer Gegend betrieben werden, in der die Umgebungstemperatur das empfohlene Maximum von 40° C überschreitet. Um Lüftungsverschluß zu verhindern, achten Sie darauf, daß mindestens 15,2 cm lichter Raum um die Lüftungsöffnungen herum frei bleibt.

Avvertenza Per evitare il surriscaldamento dei switch, non adoperateli in un locale che ecceda la temperatura ambientale massima di 40° C. Per evitare che la circolazione dell'aria sia impedita, lasciate uno spazio di almeno 15.2 cm di fronte alle aperture delle ventole.

Advarsel Unngå overoppheting av eventuelle rutere i Juniper Networks switch Disse skal ikke brukes på steder der den anbefalte maksimale omgivelsestemperaturen overstiger 40° C (104° F). Sørg for at klaringen rundt lufteåpningene er minst 15,2 cm (6 tommer) for å forhindre nedsatt luftsirkulasjon.

Aviso Para evitar o sobreaquecimento do encaminhador Juniper Networks switch, não utilize este equipamento numa área que exceda a temperatura máxima recomendada de 40° C. Para evitar a restrição à circulação de ar, deixe pelo menos um espaço de 15,2 cm à volta das aberturas de ventilação.

¡Atención! Para impedir que un encaminador de la serie Juniper Networks switch se recaliente, no lo haga funcionar en un área en la que se supere la temperatura ambiente máxima recomendada de 40° C. Para impedir la restricción de la entrada de aire, deje un espacio mínimo de 15,2 cm alrededor de las aperturas para ventilación.

Varning! Förhindra att en Juniper Networks switch överhettas genom att inte använda den i ett område där den maximalt rekommenderade omgivningstemperaturen på 40° C överskrids. Förhindra att luftcirkulationen inskränks genom att se till att det finns fritt utrymme på minst 15,2 cm omkring ventilationsöppningarna.

Product Disposal Warning



WARNING: Disposal of this device must be handled according to all national laws and regulations.

Waarschuwing Dit produkt dient volgens alle landelijke wetten en voorschriften te worden afgedankt.

Varoitus Tämän tuotteen lopullisesta hävittämisestä tulee huolehtia kaikkia valtakunnallisia lakeja ja säännöksiä noudattaen.

Avertissement La mise au rebut définitive de ce produit doit être effectuée conformément à toutes les lois et réglementations en vigueur.

Warnung Dieses Produkt muß den geltenden Gesetzen und Vorschriften entsprechend entsorgt werden.

Avvertenza L'eliminazione finale di questo prodotto deve essere eseguita osservando le normative italiane vigenti in materia

Advarsel Endelig disponering av dette produktet må skje i henhold til nasjonale lover og forskrifter.

Aviso A descartagem final deste produto deverá ser efectuada de acordo com os regulamentos e a legislação nacional.

¡Atención! El desecho final de este producto debe realizarse según todas las leyes y regulaciones nacionales

Warning! Slutlig kassering av denna produkt bör skötas i enlighet med landets alla lagar och föreskrifter.

Action to Take After an Electrical Accident

If an electrical accident results in an injury, take the following actions in this order:

1. Use caution. Be aware of potentially hazardous conditions that could cause further injury.
2. Disconnect power from the device.
3. If possible, send another person to get medical aid. Otherwise, assess the condition of the victim, then call for help.

General Electrical Safety Guidelines and Warnings

- Install the services gateway in compliance with the following local, national, or international electrical codes:
 - United States—National Fire Protection Association (NFPA 70), United States National Electrical Code
 - Canada—Canadian Electrical Code, Part 1, CSA C22.1
 - Other countries—International Electromechanical Commission (IEC) 60364, Part 1 through Part 7
 - Evaluated to the TN power system
- Locate the emergency power-off switch for the room in which you are working so that if an electrical accident occurs, you can quickly turn off the power.
- Do not work alone if potentially hazardous conditions exist anywhere in your workspace.
- Never assume that power is disconnected from a circuit. Always check the circuit before starting to work.
- Carefully look for possible hazards in your work area, such as moist floors, ungrounded power extension cords, and missing safety grounds.
- Operate the services gateway within marked electrical ratings and product usage instructions.
- For the services gateway and peripheral equipment to function safely and correctly, use the cables and connectors specified for the attached peripheral equipment, and make certain they are in good condition.

RELATED DOCUMENTATION

[In Case of Electrical Accident](#)

[AC Power Electrical Safety Guidelines](#)

AC Power Electrical Safety Guidelines

The following electrical safety guidelines apply to AC-powered devices:

- Note the following warnings printed on the device:

“**CAUTION:** THIS UNIT HAS MORE THAN ONE POWER SUPPLY CORD. DISCONNECT ALL POWER SUPPLY CORDS BEFORE SERVICING TO AVOID ELECTRIC SHOCK.”

“**ATTENTION:** CET APPAREIL COMPORTE PLUS D'UN CORDON D'ALIMENTATION. AFIN DE PRÉVENIR LES CHOCS ÉLECTRIQUES, DÉBRANCHER TOUT CORDON D'ALIMENTATION AVANT DE FAIRE LE DÉPANNAGE.”

- AC-powered devices are shipped with a three-wire electrical cord with a grounding-type plug that fits only a grounding-type power outlet. Do not circumvent this safety feature. Equipment grounding must comply with local and national electrical codes.
- You must provide an external certified 2-pole circuit breaker rated minimum 20 A for United States (16-20 A for other countries) in the building installation. Install as permitted by the local code.
- The power cord serves as the main disconnecting device for the AC-powered device. The socket outlet must be near the AC-powered device and be easily accessible.
- For devices that have more than one power supply connection, you must ensure that all power connections are fully disconnected so that power to the device is completely removed to prevent electric shock. To disconnect power, unplug all power cords (one for each power supply).

Power Cable Warning (Japanese)

WARNING: The attached power cable is only for this product. Do not use the cable for another product.

注意

附属の電源コードセットはこの製品専用です。
他の電気機器には使用しないでください。

0417283

SSR120 Agency Approvals

The SSR120 appliance complies with the following standards:

- Safety
 - NRTL: UL 62368-1 & 60950-1 (Second Edition)
 - CAN/CSA-C22.2 62368-1 & 60950-1 (Second Edition)
 - CB: EN/IEC 62368-1 & 60950-1 (all country deviations)

- EN/IEC 60825-2
- EMC
 - FCC 47 CFR Part 15
 - ICES-003
 - EN 300 386 V1.6.1 & V2.1.1
 - CISPR 32/EN 55032
 - CISPR 35/EN 55035
 - AS/NZS CISPR 32
 - VCCI-CISPR 32
 - KN 32 and KN 35
 - BSMI CNS 13438
 - EN/IEC 61000 Series
 - TEC/SD/DD/EMC-221/05/OCT-16
 - QCVN 118:2018/BTTTT and TCVN 7317
- Environmental
 - Reduction of hazardous Substances (ROHS) 6of6 with no exemptions
 - 7a exemption for power supply components acceptable
- Homologation
 - Argentina - EQUIPO DE USO IDÓNEO.
- Radio - Only for SSR models that support LTE
 - EN 301 489-1
 - EN 62311
 - EN 50665
 - EN 301 908-1
 - EN 301 908-2
 - EN 301 908-13

- ETSI TS 136 521-1

FCC Declarations

This equipment has been tested and found to comply with the limits for a Class B digital device, pursuant to part 15 of the FCC Rules. These limits are designed to provide reasonable protection against harmful interference in a residential installation. This equipment generates, uses and can radiate radio frequency energy and, if not installed and used in accordance with the instructions, may cause harmful interference to radio communications. However, there is no guarantee that interference will not occur in a particular installation.

Lithium Battery Declaration

The appliance has a CR2032 lithium battery. Follow the guidelines while replacing the battery:

- There is a danger of explosion if the battery is replaced incorrectly.
- Replace the battery only with the same or equivalent type.
- Dispose used batteries according to the local laws and regulations regarding safe disposal of lithium batteries.
- Disposal of a battery into a fire or by crushing or puncturing it can result in an explosion.
- Exposing a battery to extremely hot temperatures might result in leakage of flammable gas or explosion.
- Do not ingest battery. Chemical burn hazard. This product contains a coin/ button cell battery. If the coin/button cell battery is swallowed, it can cause severe internal burns in just 2 hours and can lead to death. Keep new and used batteries away from children. If the battery compartment does not close securely, stop using the product and keep it away from children. If you think batteries could have been swallowed or placed inside any part of the body, seek immediate medical attention.